



Votre art mérite le meilleur des supports.

## HISTORIQUE

MDB PROFIL est présente depuis plus de 40 ans dans le domaine du parachèvement du bâtiment. Elle offre à ses partenaires négociants une réponse pertinente à une question essentielle : trouver chez un même fournisseur les profilés et accessoires dédiés aux 4 métiers de la finition (parachèvement des plaques de plâtre, enduisages intérieurs et extérieurs, et les systèmes d'isolation de façades par l'extérieur-ITE). Cette offre a contribué, au fil des années, à la construction de notre renommée, grâce à un service axé sur la qualité, le choix et l'innovation.

### **LA QUALITÉ :**

Tant au niveau de la qualité des produits proposés que des matières utilisées pour leur fabrication, MDB PROFIL met un point d'honneur à fournir à ses clients des articles d'une qualité irréprochable. Et cette volonté se prolonge jusque dans le choix de nos partenaires commerciaux, que nous sélectionnons avant tout pour leurs compétences dans leur domaine. Cette recherche constante du « meilleur pour vous » nous permet ainsi de respecter scrupuleusement les normes qualitatives européennes dictées par la Fédération « Europrofilés ».

### **LE CHOIX :**

Afin de répondre à la moindre de vos demandes, MDB PROFIL dispose d'une large gamme de profilés et d'accessoires, dans de multiples matières et dimensions. Grâce à une énorme capacité de stockage interne et externe, nous sommes capables de satisfaire votre demande au plus vite, ou le cas échéant de vous orienter vers une alternative plus rapide. Et avec le réseau de distribution étendu dont nous bénéficions sur tout le Benelux, en Europe et au-delà, notre soutien logistique participe amplement à cette vitesse de réaction.

### **L'INNOVATION :**

La volonté d'excellence que nous souhaitons offrir à nos clients se traduit également à travers notre écoute attentive du marché. Celle-ci nous permet de sonder les besoins de vos clients entrepreneurs, en recherchant les solutions qui leur permettront d'améliorer leur rentabilité sur les chantiers.

Ces points forts, aujourd'hui, guident la relation que nous entretenons au quotidien avec nos partenaires distributeurs de matériaux de construction. Ils ont forgé notre réputation de leader sur le marché, avec une seule ligne directrice : la satisfaction du client.



Uw vakmanschap verdient de beste ondersteuning.

## HISTORIEK

MDB PROFIL is reeds meer dan 40 jaar actief in de wereld van de bouwafwerking waarbij we door de jaren heen, op basis van kwaliteit, service, keuze en innovatie een reputatie hebben opgebouwd van betrouwbaar leverancier met relevant voordeel : het aanbieden van zowel profielen als toebehoren voor de 4 grote deelgroepen van de afbouw (droogbouw, binnen-en buitenbepleistering en gevelisolatie systemen).

### **KWALITEIT:**

MDB PROFIL vindt het essentieel om haar klanten producten van onberispelijke kwaliteit aan te bieden. Dit geldt voor de producten zelf als voor de materialen waaruit ze worden vervaardigd. Deze wil uit zich in onze keuze van onze handelspartners welke wij selecteren voor hun vaardigheden en vakmanschap. Deze constante zoektocht naar "het beste voor u" laat ons toe de door "Europrofiles" opgelegde Europese kwaliteitsnormen nauwgezet na te leven.

### **DE KEUZE:**

Om aan alle aanvragen te beantwoorden beschikt MDB PROFIL over een uitgebreid gamma profielen en toebehoren in diverse uitvoeringen, materialen en afmetingen. Deze enorme voorraadcapaciteit plus een ruim verdeelnetwerk in Benelux, verder binnen en zelfs buiten Europa laat ons toe snel aan uw verzoek te voldoen of u via een passend alternatief verder te helpen.

### **INNOVATIE:**

Een constante aanwezigheid en oplettend beluisteren van de afbouwmarkt laat MDB PROFIL toe continu het gamma aan te passen aan de wensen en behoeften van het moment. Dit met als doel oplossingen aan te bieden welke de werfrentabiliteit van de ondernemer verbeteren.

Dagdagelijks begeleiden deze sterke punten onze relatie met alle distributiepartners. Ze hebben onze reputatie van marktleider gesmeed met één richtlijn: de tevredenheid van de klant.

## PLAQUES DE PLÂTRE DROOGBOUW

## PROFILÉS D'ANGLE HOEKPROFIELEN

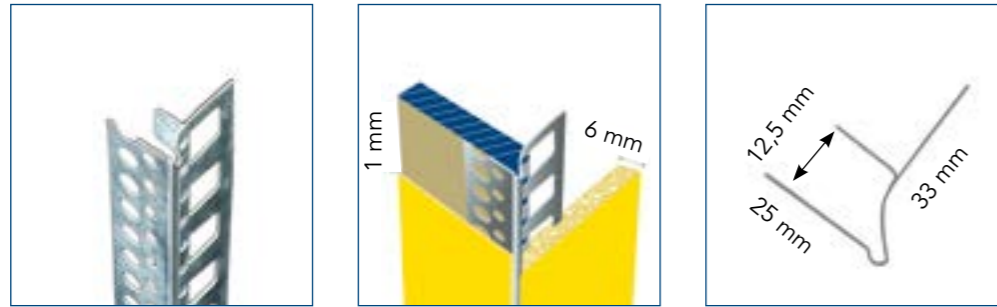

NOM NAAM	EP. D'ENDUIT PLEISTERDIKTE	PLAQUE DE PLÂTRE GIPSKARTONPLAAT	STOCK STOCK	NR ARTICLE ARTIKEL NR	DIMENSION AFMETING	PIÈCES/EMB. STUKS/VERP.	ML/EMB. LM/VERP.	EMB./PAL. VERP./PAL.
CORNERPLAC	0103	1+6 mm		0103010230	2,30 m	10	23,00	120
	0103	1+6 mm		0103010300	3,00 m	10	30,00	120
CORNERPLAC ALU	0203	1+6 mm		0203010300	3,00 m	10	30,00	120



NOM NAAM	EP. D'ENDUIT PLEISTERDIKTE	PLAQUE DE PLÂTRE GIPSKARTONPLAAT	STOCK STOCK	NR ARTICLE ARTIKEL NR	DIMENSION AFMETING	PIÈCES/EMB. STUKS/VERP.	ML/EMB. LM/VERP.	EMB./PAL. VERP./PAL.
MICROMESH	0113	1 mm		0113060245	2,45 m	60	147,00	48
	0113	1 mm		0113060275	2,75 m	60	165,00	48
	0113	1 mm		0113060305	3,05 m	60	183,00	48

## PROFILÉS D'ANGLE HOEKPROFIELEN

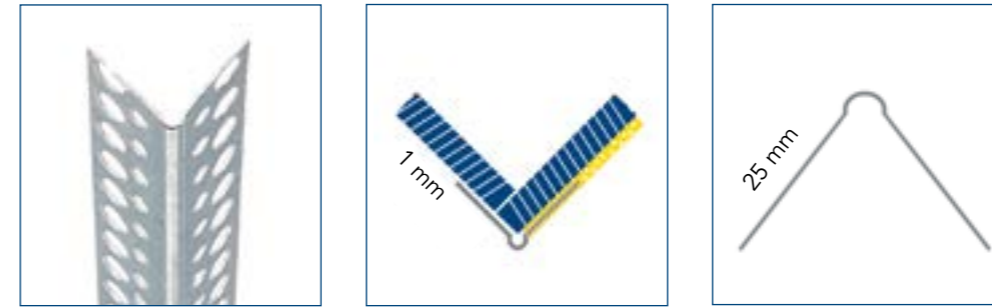

NOM NAAM	EP. D'ENDUIT PLEISTERDIKTE	PLAQUE DE PLÂTRE GIPSKARTONPLAAT	STOCK STOCK	NR ARTICLE ARTIKEL NR	DIMENSION AFMETING	PIÈCES/EMB. STUKS/VERP.	ML/EMB. LM/VERP.	EMB./PAL. VERP./PAL.
GALVAPLAC	0114	1 mm		0114025260	2,60 m	25	65,00	160
	0114	1 mm		0114025300	3,00 m	25	75,00	160
ALUPLAC	0218	1 mm		0218100200	2,00 m	100	200,00	80
	0218	1 mm		0218100250	2,50 m	100	250,00	80
	0218	1 mm		0218100300	3,00 m	100	300,00	80
INOPLAC	0494	1 mm		0494025250	2,50 m	25	62,50	160
	0494	1 mm		0494025300	3,00 m	25	75,00	160

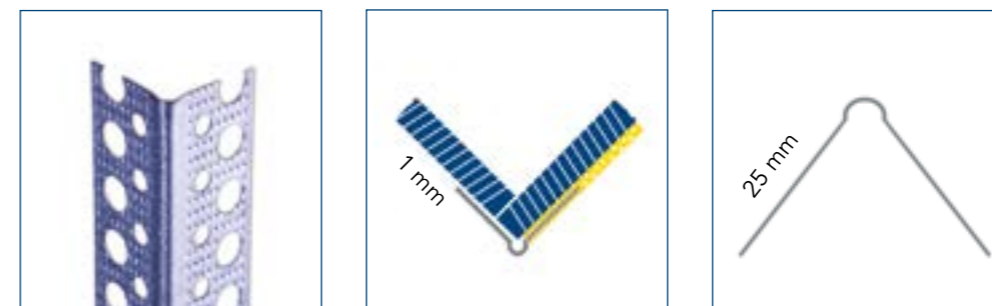

NOM NAAM	EP. D'ENDUIT PLEISTERDIKTE	PLAQUE DE PLÂTRE GIPSKARTONPLAAT	STOCK STOCK	NR ARTICLE ARTIKEL NR	DIMENSION AFMETING	PIÈCES/EMB. STUKS/VERP.	ML/EMB. LM/VERP.	EMB./PAL. VERP./PAL.
GALVAPLAC ECO	0164	1 mm		0164025250	2,50 m	25	62,50	80
	0164	1 mm		0164025300	3,00 m	25	75,00	80
	0164	1 mm		0164050250	2,50 m	50	125,00	80
	0164	1 mm		0164050300	3,00 m	50	150,00	80
ALUPLAC ECO	0264	1 mm	S	0264200250	2,50 m	200	500,00	44
	0264	1 mm	S	0264200300	3,00 m	200	600,00	44

## PROFILÉS D'ANGLE HOEKPROFIELEN

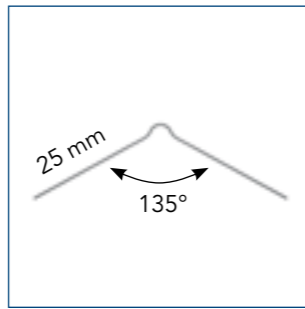
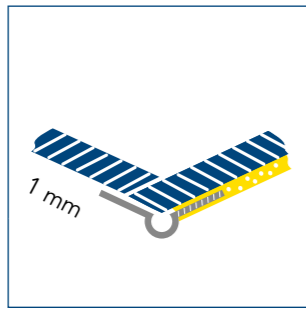

NOM NAAM	EP. D'ENDUIT PLEISTERDIKTE	PLAQUE DE PLÂTRE GIPSKARTONPLAAT	STOCK STOCK	NR ARTICLE ARTIKEL NR	DIMENSION AFMETING	PIÈCES/EMB. STUKS/VERP.	ML/EMB. LM/VERP.	EMB./PAL. VERP./PAL.	
ALUPLAC	0217	1 mm	-	S	0217050300	3,00 m	50	150,00	100

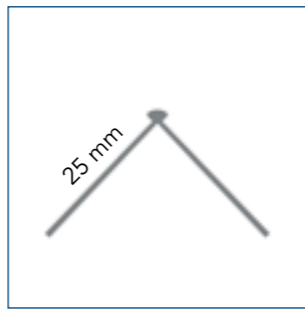
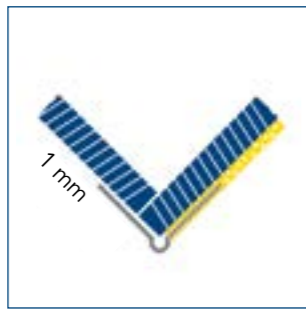

NOM NAAM	EP. D'ENDUIT PLEISTERDIKTE	PLAQUE DE PLÂTRE GIPSKARTONPLAAT	STOCK STOCK	NR ARTICLE ARTIKEL NR	DIMENSION AFMETING	PIÈCES/EMB. STUKS/VERP.	ML/EMB. LM/VERP.	EMB./PAL. VERP./PAL.	
CORNER BEAD PVC	8001	1 mm	-		8001050300	3,00 m	50	150,00	40

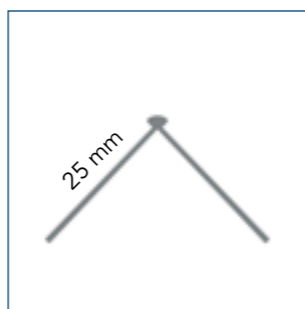
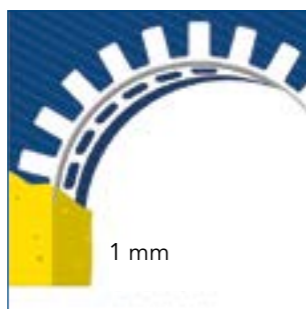
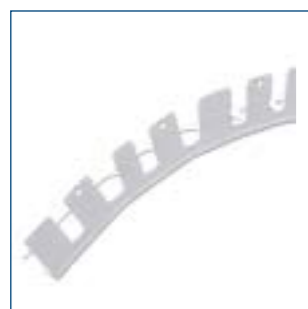

NOM NAAM	EP. D'ENDUIT PLEISTERDIKTE	PLAQUE DE PLÂTRE GIPSKARTONPLAAT	STOCK STOCK	NR ARTICLE ARTIKEL NR	DIMENSION AFMETING	PIÈCES/EMB. STUKS/VERP.	ML/EMB. LM/VERP.	EMB./PAL. VERP./PAL.	
RONDO PLAC PVC	8201	1 mm	-	S	8201050300	3,00 m	50	150,00	40

## PROFILÉS D'ANGLE HOEKPROFIELEN

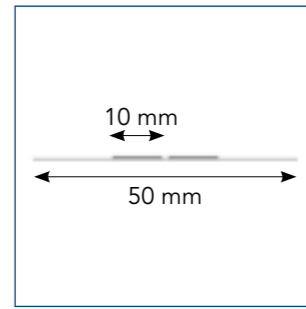
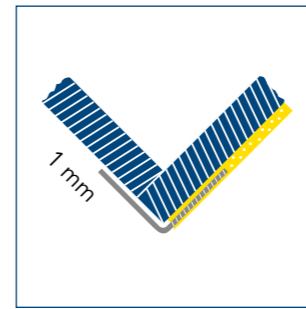

NOM NAAM	EP. D'ENDUIT PLEISTERDIKTE	PLAQUE DE PLÂTRE GIPSKARTONPLAAT	STOCK STOCK	NR ARTICLE ARTIKEL NR	DIMENSION AFMETING	PIÈCES/EMB. STUKS/VERP.	ML/EMB. LM/VERP.	EMB./PAL. VERP./PAL.	
UNIFLEX CORNER	5230	1 mm	-	S	5230010300	30,00 m	10	300,00	42
UNIFLEX CORNER PVC	5237	1 mm	-		5237010300	30,00 m	10	300,00	30

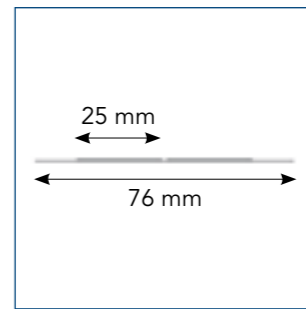
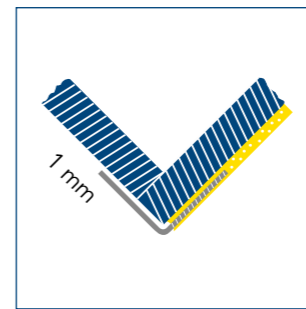

NOM NAAM	EP. D'ENDUIT PLEISTERDIKTE	PLAQUE DE PLÂTRE GIPSKARTONPLAAT	STOCK STOCK	NR ARTICLE ARTIKEL NR	DIMENSION AFMETING	PIÈCES/EMB. STUKS/VERP.	ML/EMB. LM/VERP.	EMB./PAL. VERP./PAL.	
STRAITFLEX MID FLEX 300	5300	1 mm	-	S	5300010305	30,50 m	10	305,00	24

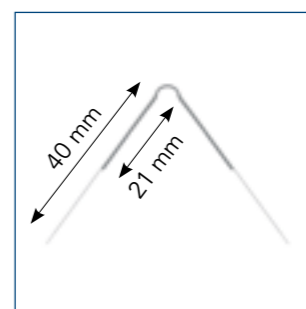
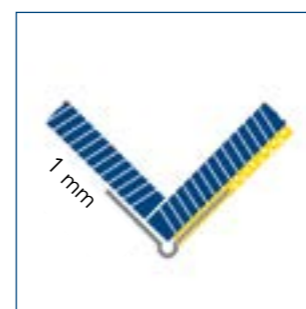

NOM NAAM	EP. D'ENDUIT PLEISTERDIKTE	PLAQUE DE PLÂTRE GIPSKARTONPLAAT	STOCK STOCK	NR ARTICLE ARTIKEL NR	DIMENSION AFMETING	PIÈCES/EMB. STUKS/VERP.	ML/EMB. LM/VERP.	EMB./PAL. VERP./PAL.	
PAPER CORNER BEAD	5301	1 mm	-	S	5301050305	3,05 m	50	152,50	24

## PROFILÉS D'ANGLE HOEKPROFIELEN

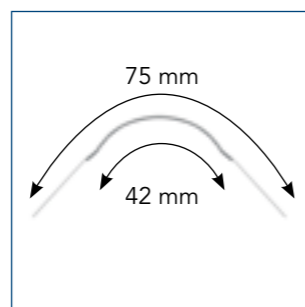
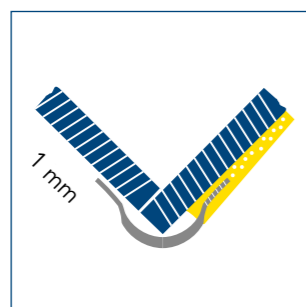

NOM NAAM	EP. D'ENDUIT PLEISTERDIKTE	PLAQUE DE PLÂTRE GIPSKARTONPLAAT	STOCK STOCK	NR ARTICLE ARTIKEL NR	DIMENSION AFMETING	PIÈCES/EMB. STUKS/VERP.	ML/EMB. LM/VERP.	EMB./PAL. VERP./PAL.	
<b>BIG-BULL</b>	5302	1 mm	-	S	5302050305	3,05 m	50	152,50	28

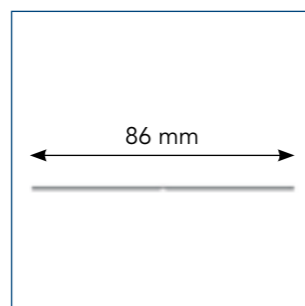
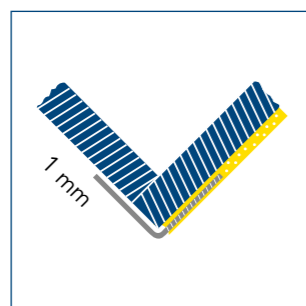

NOM NAAM	EP. D'ENDUIT PLEISTERDIKTE	PLAQUE DE PLÂTRE GIPSKARTONPLAAT	STOCK STOCK	NR ARTICLE ARTIKEL NR	DIMENSION AFMETING	PIÈCES/EMB. STUKS/VERP.	ML/EMB. LM/VERP.	EMB./PAL. VERP./PAL.	
<b>STRAITFLEX ARCH-FLEX 333</b>	5303	1 mm	-	S	5303012305	30,50 m	12	366,00	24

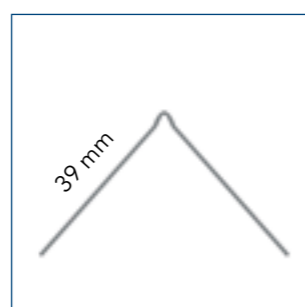

NOM NAAM	EP. D'ENDUIT PLEISTERDIKTE	PLAQUE DE PLÂTRE GIPSKARTONPLAAT	STOCK STOCK	NR ARTICLE ARTIKEL NR	DIMENSION AFMETING	PIÈCES/EMB. STUKS/VERP.	ML/EMB. LM/VERP.	EMB./PAL. VERP./PAL.	
<b>CORNER BEAD WET-STICK</b>	5306	1 mm	-	S	5306050305	3,05 m	50	152,50	24

## PROFILÉS D'ANGLE HOEKPROFIELEN

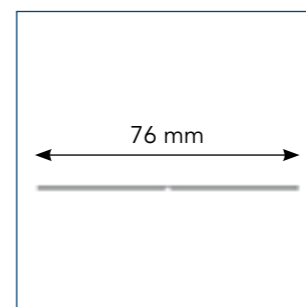
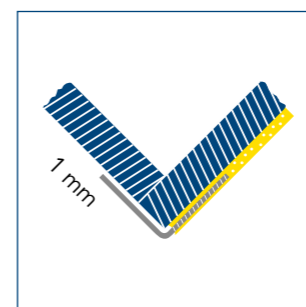

NOM NAAM	EP. D'ENDUIT PLEISTERDIKTE	PLAQUE DE PLÂTRE GIPSKARTONPLAAT	STOCK STOCK	NR ARTICLE ARTIKEL NR	DIMENSION AFMETING	PIÈCES/EMB. STUKS/VERP.	ML/EMB. LM/VERP.	EMB./PAL. VERP./PAL.	
<b>WET-FLEX</b>	5307	1 mm	-	S	5307008305	30,50 m	8	244,00	24

## PROFILÉS D'ARRÊT STOP- & AFWERKPROFIELEN

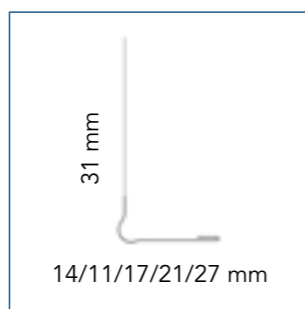
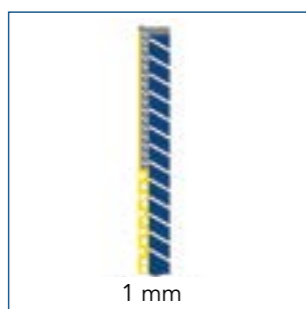

NOM NAAM	EP. D'ENDUIT PLEISTERDIKTE	PLAQUE DE PLÂTRE GIPSKARTONPLAAT	STOCK STOCK	NR ARTICLE ARTIKEL NR	DIMENSION AFMETING	PIÈCES/EMB. STUKS/VERP.	ML/EMB. LM/VERP.	EMB./PAL. VERP./PAL.
PLASTO MICRO	0128	1 mm		0128050305	3,05 m	50	152,50	66
	0191	1 mm		0191050305	3,05 m	50	152,50	66
	0192	1 mm		0192045305	3,05 m	45	137,25	66
	0193	1 mm		0193045305	3,05 m	45	137,25	66
	0194	1 mm		0194040305	3,05 m	40	122,00	66

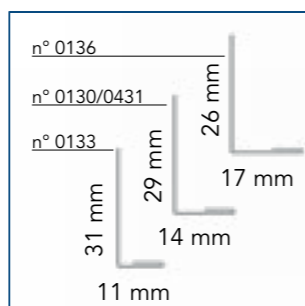
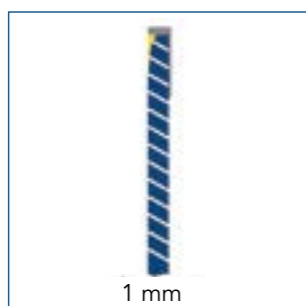

NOM NAAM	EP. D'ENDUIT PLEISTERDIKTE	PLAQUE DE PLÂTRE GIPSKARTONPLAAT	STOCK STOCK	NR ARTICLE ARTIKEL NR	DIMENSION AFMETING	PIÈCES/EMB. STUKS/VERP.	ML/EMB. LM/VERP.	EMB./PAL. VERP./PAL.
PLACSTOP L	0130	1 mm		0130025300	3,00 m	25	75,00	50
	0133	1 mm		0133025300	3,00 m	25	75,00	50
	0136	1 mm		0136025300	3,00 m	25	75,00	50
PLACSTOP L INOX	0431	1 mm		0431025300	3,00 m	25	75,00	50

## PROFILÉS D'ARRÊT STOP- & AFWERKPROFIELEN

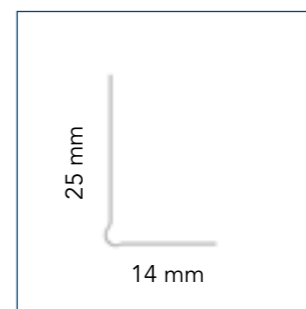
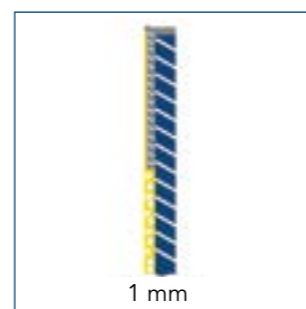

NOM NAAM	EP. D'ENDUIT PLEISTERDIKTE	PLAQUE DE PLÂTRE GIPSKARTONPLAAT	STOCK STOCK	NR ARTICLE ARTIKEL NR	DIMENSION AFMETING	PIÈCES/EMB. STUKS/VERP.	ML/EMB. LM/VERP.	EMB./PAL. VERP./PAL.
PLACSTOP ALU	0229	1 mm		0229050300	3,00 m	50	150,00	160

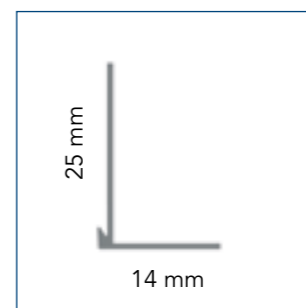
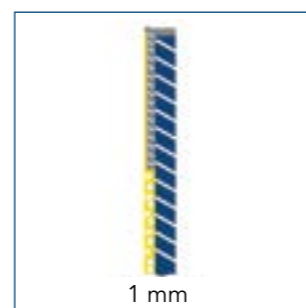

NOM NAAM	EP. D'ENDUIT PLEISTERDIKTE	PLAQUE DE PLÂTRE GIPSKARTONPLAAT	STOCK STOCK	NR ARTICLE ARTIKEL NR	DIMENSION AFMETING	PIÈCES/EMB. STUKS/VERP.	ML/EMB. LM/VERP.	EMB./PAL. VERP./PAL.
PLACSTOP PVC	8025	1 mm		8025025300	3,00 m	25	75,00	40

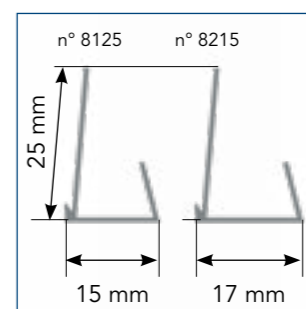
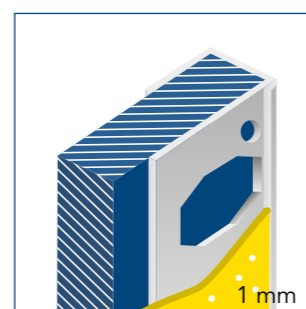

NOM NAAM	EP. D'ENDUIT PLEISTERDIKTE	PLAQUE DE PLÂTRE GIPSKARTONPLAAT	STOCK STOCK	NR ARTICLE ARTIKEL NR	DIMENSION AFMETING	PIÈCES/EMB. STUKS/VERP.	ML/EMB. LM/VERP.	EMB./PAL. VERP./PAL.
PLACSTOP PVC	8125	1 mm		8125025300	3,00 m	25	75,00	40
	8215	1 mm		8215025300	3,00 m	25	75,00	40

## PROFILÉS D'ARRÊT STOP- & AFWERKPROFIELEN

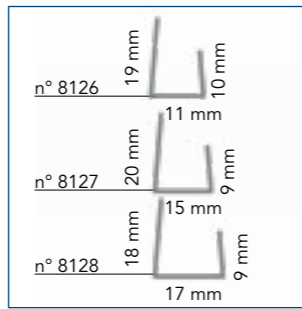
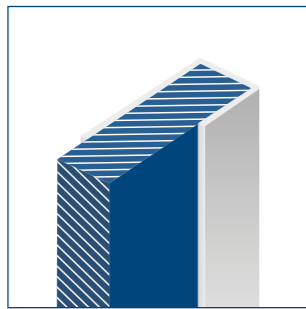

NOM NAAM	EP. D'ENDUIT PLEISTERDIKTE	PLAQUE DE PLÂTRE GIPSKARTONPLAAT	STOCK STOCK	NR ARTICLE ARTIKEL NR	DIMENSION AFMETING	PIÈCES/EMB. STUKS/VERP.	ML/EMB. LM/VERP.	EMB./PAL. VERP./PAL.
PLACSTOP PVC	8126	-		8126050300	3,00 m	50	150,00	70
	8127	-		8127050300	3,00 m	50	150,00	100
	8128	-		8128050300	3,00 m	50	150,00	100

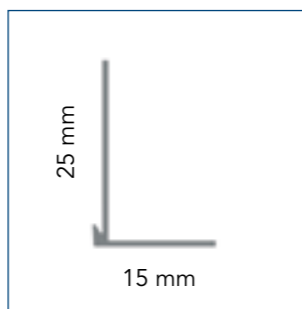
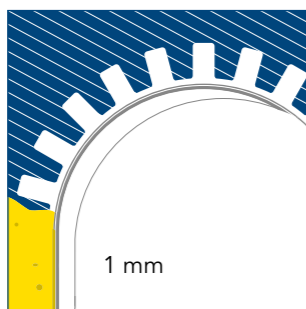

NOM NAAM	EP. D'ENDUIT PLEISTERDIKTE	PLAQUE DE PLÂTRE GIPSKARTONPLAAT	STOCK STOCK	NR ARTICLE ARTIKEL NR	DIMENSION AFMETING	PIÈCES/EMB. STUKS/VERP.	ML/EMB. LM/VERP.	EMB./PAL. VERP./PAL.
PLACSTOP RONDO PVC	8225	1 mm		8225025300	3,00 m	25	75,00	75

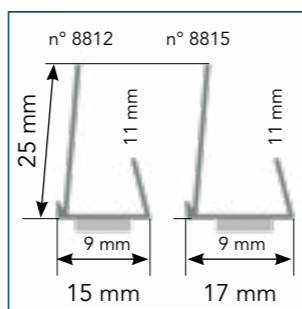
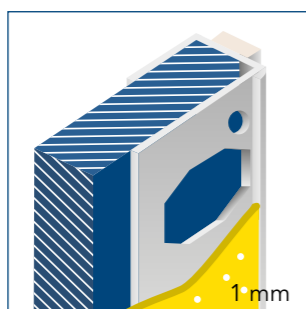

NOM NAAM	EP. D'ENDUIT PLEISTERDIKTE	PLAQUE DE PLÂTRE GIPSKARTONPLAAT	STOCK STOCK	NR ARTICLE ARTIKEL NR	DIMENSION AFMETING	PIÈCES/EMB. STUKS/VERP.	ML/EMB. LM/VERP.	EMB./PAL. VERP./PAL.
PLACSTOP TAPE PVC	8812	1 mm		8812025250	2,50 m	25	62,50	40
	8815	1 mm		8815025250	2,50 m	25	62,50	40

## PROFILÉS D'ARRÊT STOP- & AFWERKPROFIELEN

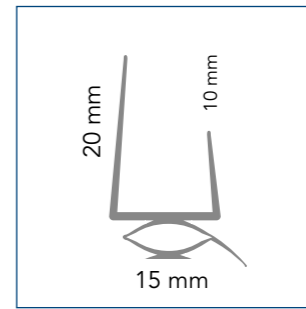
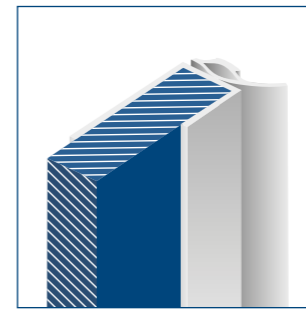

NOM NAAM	EP. D'ENDUIT PLEISTERDIKTE	PLAQUE DE PLÂTRE GIPSKARTONPLAAT	STOCK STOCK	NR ARTICLE ARTIKEL NR	DIMENSION AFMETING	PIÈCES/EMB. STUKS/VERP.	ML/EMB. LM/VERP.	EMB./PAL. VERP./PAL.
PLACSTOP LIPPE PVC	8825	-	S	8825030250	2,50 m	30	75,00	60

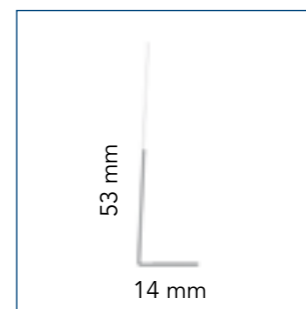
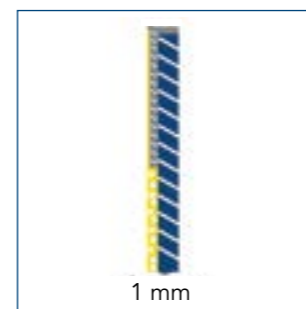
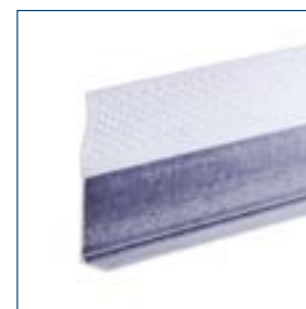

NOM NAAM	EP. D'ENDUIT PLEISTERDIKTE	PLAQUE DE PLÂTRE GIPSKARTONPLAAT	STOCK STOCK	NR ARTICLE ARTIKEL NR	DIMENSION AFMETING	PIÈCES/EMB. STUKS/VERP.	ML/EMB. LM/VERP.	EMB./PAL. VERP./PAL.
PAPER STOP BEAD	5305	1 mm	S	5305050275	2,75 m	50	137,50	24

## PROFILÉS D'OMBRAGE SCHADUWPROFIELEN

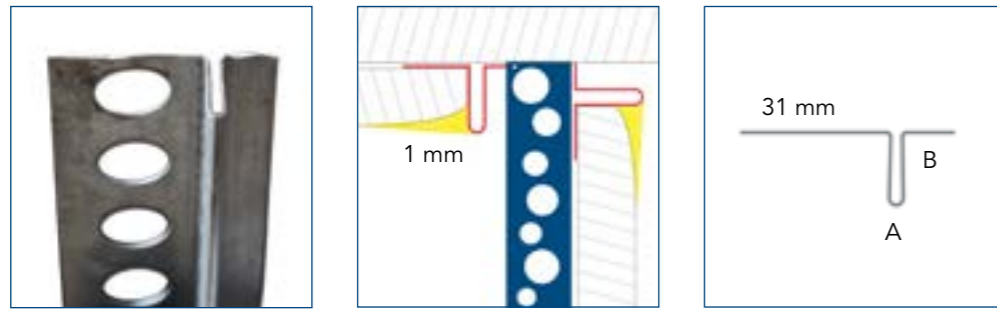

NOM NAAM	EP. D'ENDUIT PLEISTERDIKTE	PLAQUE PLAAT	A (H)	B (Joint) B (Lip)	NR ARTICLE ARTIKEL NR	DIMENSION AFMETING	PIÈCES/EMB. STUKS/VERP.	ML/EMB. LM/VERP.	EMB./PAL. VERP./PAL.
CADERPLAC L	0161*	1 mm	12,5 mm	14 mm	0161015300	3,00 m	15	45,00	80
	0162*	1 mm	12,5 mm	14 mm	0162015300	3,00 m	15	45,00	80
	0169*	1 mm	12,5 mm	14 mm	0169015300	3,00 m	15	45,00	80
	0163*	1 mm	12,5 mm	14 mm	0163015300	3,00 m	15	45,00	80
	0170*	1 mm	12,5 mm	14 mm	0170015300	3,00 m	15	45,00	80
	0165*	1 mm	15 mm	16 mm	0165015300	3,00 m	15	45,00	80
	0166*	1 mm	15 mm	16 mm	0166015300	3,00 m	15	45,00	80
	0167*	1 mm	15 mm	16 mm	0167015300	3,00 m	15	45,00	80
	0168*	1 mm	15 mm	16 mm	0168015300	3,00 m	15	45,00	80

\* Pas de stock / Niet op voorraad

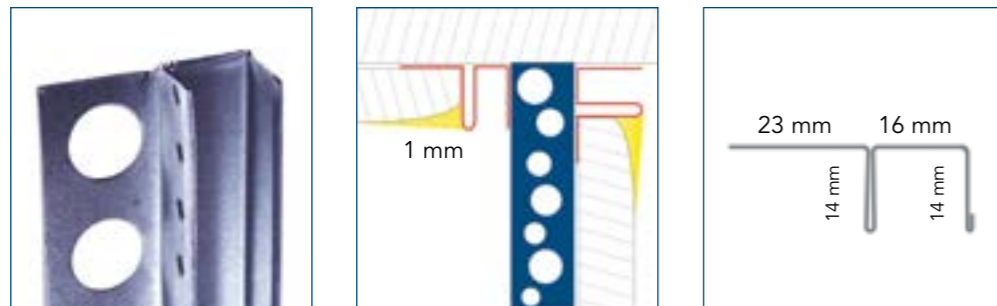

NOM NAAM	EP. D'ENDUIT PLEISTERDIKTE	PLAQUE DE PLÂTRE GIPSKARTONPLAAT	STOCK STOCK	NR ARTICLE ARTIKEL NR	DIMENSION AFMETING	PIÈCES/EMB. STUKS/VERP.	ML/EMB. LM/VERP.	EMB./PAL. VERP./PAL.
CADERPLAC U	0171	1 mm		0171015300	3,00 m	15	45,00	80

## PROFILÉS D'OMBRAGE SCHADUWPROFIELEN

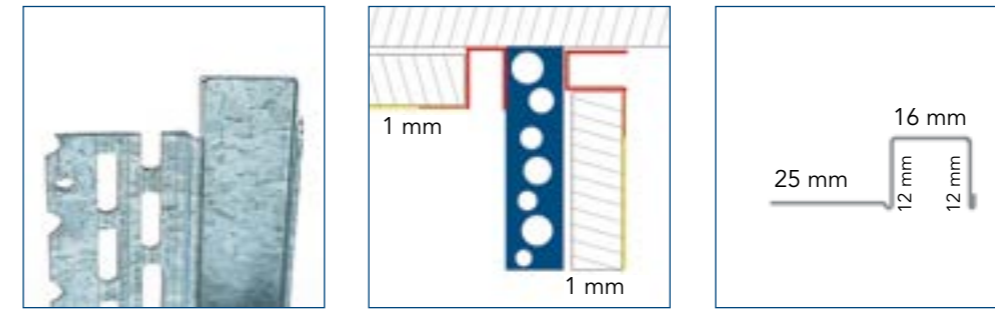

NOM NAAM	EP. D'ENDUIT PLEISTERDIKTE	PLAQUE DE PLÂTRE GIPSKARTONPLAAT	STOCK STOCK	NR ARTICLE ARTIKEL NR	DIMENSION AFMETING	PIÈCES/EMB. STUKS/VERP.	ML/EMB. LM/VERP.	EMB./PAL. VERP./PAL.
CADERPLAC U	0173	1 mm		0173025300	3,00 m	25	75,00	80

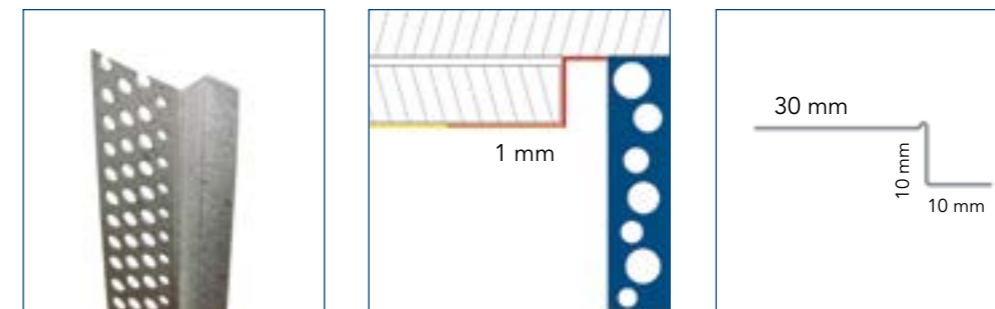

NOM NAAM	EP. D'ENDUIT PLEISTERDIKTE	PLAQUE DE PLÂTRE GIPSKARTONPLAAT	STOCK STOCK	NR ARTICLE ARTIKEL NR	DIMENSION AFMETING	PIÈCES/EMB. STUKS/VERP.	ML/EMB. LM/VERP.	EMB./PAL. VERP./PAL.
PLACSTOP Z	0195	1 mm		0195025250	2,50 m	25	62,50	160
	0195	1 mm		0195025300	3,00 m	25	75,00	160

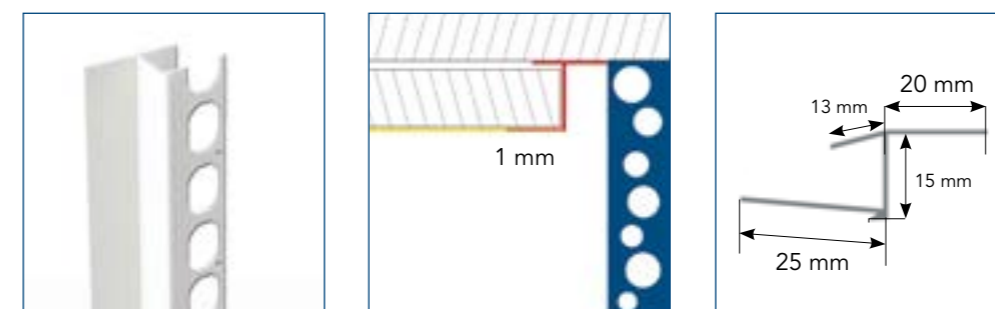

NOM NAAM	EP. D'ENDUIT PLEISTERDIKTE	PLAQUE DE PLÂTRE GIPSKARTONPLAAT	STOCK STOCK	NR ARTICLE ARTIKEL NR	DIMENSION AFMETING	PIÈCES/EMB. STUKS/VERP.	ML/EMB. LM/VERP.	EMB./PAL. VERP./PAL.
CADERPLAC L PVC	8026	1 mm	S	8026025300	3,00 m	25	75,00	40



## PROFILÉS D'OMBRAGE SCHADUWPROFIELEN

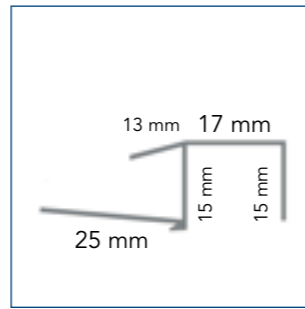
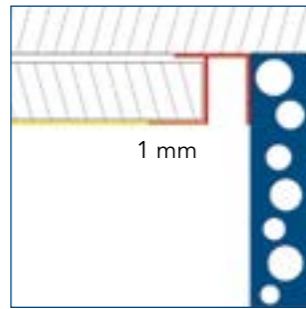

NOM NAAM	EP. D'ENDUIT PLEISTERDIKTE	PLAQUE DE PLÂTRE GIPSKARTONPLAAT	STOCK STOCK	NR ARTICLE ARTIKEL NR	DIMENSION AFMETING	PIÈCES/EMB. STUKS/VERP.	ML/EMB. LM/VERP.	EMB./PAL. VERP./PAL.
<b>CADERPLAC U PVC</b> 8027	1 mm	9,5 > 25 mm	S	8027025300	3,00 m	25	75,00	40

## PROFILÉS DE DILATATION UITZETTINGSPROFIELEN

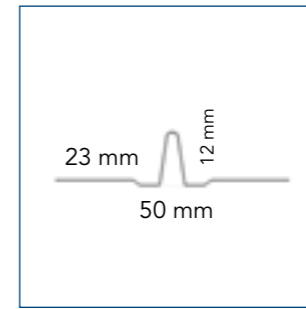
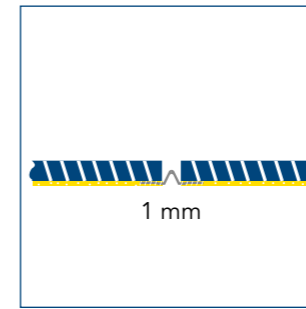

NOM NAAM	EP. D'ENDUIT PLEISTERDIKTE	PLAQUE DE PLÂTRE GIPSKARTONPLAAT	STOCK STOCK	NR ARTICLE ARTIKEL NR	DIMENSION AFMETING	PIÈCES/EMB. STUKS/VERP.	ML/EMB. LM/VERP.	EMB./PAL. VERP./PAL.
<b>CONTROL JOINT ALU</b> 0200	1 mm	-	S	0200025300	3,00 m	25	75,00	48

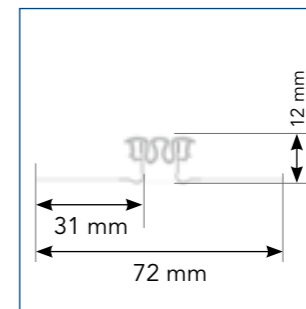
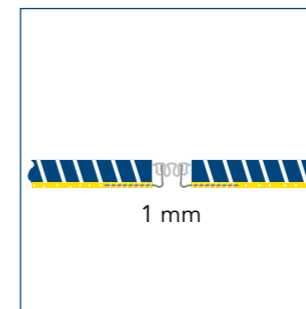

NOM NAAM	EP. D'ENDUIT PLEISTERDIKTE	PLAQUE DE PLÂTRE GIPSKARTONPLAAT	STOCK STOCK	NR ARTICLE ARTIKEL NR	DIMENSION AFMETING	PIÈCES/EMB. STUKS/VERP.	ML/EMB. LM/VERP.	EMB./PAL. VERP./PAL.
<b>DILATMESH</b> 2191	1 mm	-		2191010300	3,00 m	10	30,00	60

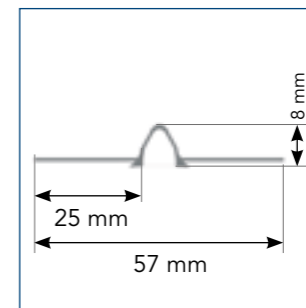
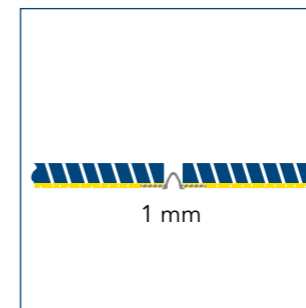

NOM NAAM	EP. D'ENDUIT PLEISTERDIKTE	PLAQUE DE PLÂTRE GIPSKARTONPLAAT	STOCK STOCK	NR ARTICLE ARTIKEL NR	DIMENSION AFMETING	PIÈCES/EMB. STUKS/VERP.	ML/EMB. LM/VERP.	EMB./PAL. VERP./PAL.
<b>DILATPLAC PVC</b> 8501	1 mm	-		8501025300	3,00 m	25	75,00	40

## PROFILÉS DE DILATATION UITZETTINGSPROFIELEN

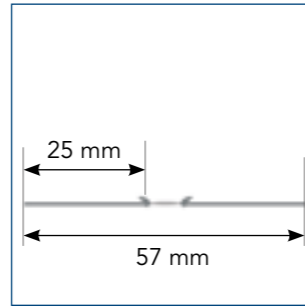
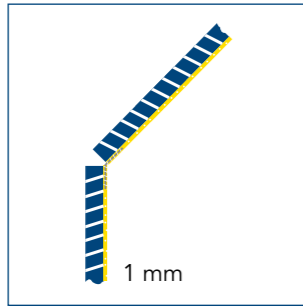

NOM NAAM	EP. D'ENDUIT PLEISTERDIKTE	PLAQUE DE PLÂTRE GIPSKARTONPLAAT	STOCK STOCK	NR ARTICLE ARTIKEL NR	DIMENSION AFMETING	PIÈCES/EMB. STUKS/VERP.	ML/EMB. LM/VERP.	EMB./PAL. VERP./PAL.
<b>FLEX JOINT PVC</b>	8511	1 mm	-	8511025250	2,50 m	25	62,50	40

## JOUES DE FENÊTRE DAGKANT ELEMENTEN

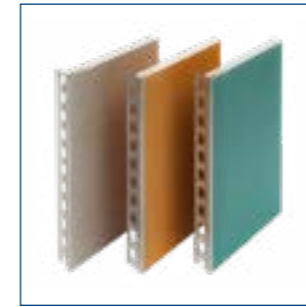

NOM NAAM	LARGEUR BREEDTE	STOCK STOCK	NR ARTICLE ARTIKEL NR	DIMENSION AFMETING	PIÈCES/EMB. STUKS/VERP.
JOUE DE FENÊTRE / DAGKANT ELEMENT (galva / verzinkt) *	1151	110 - 145 mm	1151110220	2,20 m	1
			1151110260	2,60 m	
			1151110300	3,00 m	
	1152	146 - 170 mm	1152146220	2,20 m	1
			1152146260	2,60 m	
			1152146300	3,00 m	
	1153	171 - 195 mm	1153171220	2,20 m	1
			1153171260	2,60 m	
			1153171300	3,00 m	
	1154	196 - 234 mm	1154196220	2,20 m	1
			1154196260	2,60 m	
			1154196300	3,00 m	
	1155	235 mm	1155235220	2,20 m	1
			1155235260	2,60 m	
			1155235300	3,00 m	
	1156	236 - 295 mm	1156236220	2,20 m	1
			1156236260	2,60 m	
			1156236300	3,00 m	
	1157	296 - 395 mm	1157296220	2,20 m	1
			1157296260	2,60 m	
			1157296300	3,00 m	
	1158	396 - 450 mm	1158396220	2,20 m	1
			1158396260	2,60 m	
			1158396300	3,00 m	

\* Plaque de plâtre standard 12,5 mm / Standaard gipskartonplaat 12,5 mm

## JOUES DE FENÊTRE DAGKANT ELEMENTEN

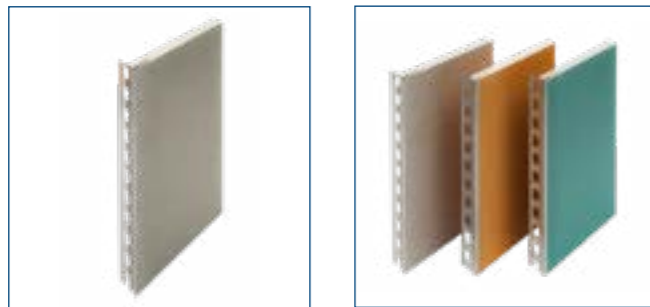

NOM NAAM	LARGEUR BREEDTE	STOCK STOCK	NR ARTICLE ARTIKEL NR	DIMENSION AFMETING	PIÈCES/EMB. STUKS/VERP.
JOUE DE FENÊTRE / DAGKANT ELEMENT (aluminium) *	1251	110 - 145 mm	1251110220	2,20 m	1
			1251110260	2,60 m	
			1251110300	3,00 m	
	1252	146 - 170 mm	1252146220	2,20 m	1
			1252146260	2,60 m	
			1252146300	3,00 m	
	1253	171 - 195 mm	1253171220	2,20 m	1
			1253171260	2,60 m	
			1253171300	3,00 m	
	1254	196 - 234 mm	1254196220	2,20 m	1
			1254196260	2,60 m	
			1254196300	3,00 m	
	1255	235 mm	1255235220	2,20 m	1
			1255235260	2,60 m	
			1255235300	3,00 m	
	1256	236 - 295 mm	1256236220	2,20 m	1
			1256236260	2,60 m	
			1256236300	3,00 m	
	1257	296 - 395 mm	1257296220	2,20 m	1
			1257296260	2,60 m	
			1257296300	3,00 m	
	1258	396 - 450 mm	1258396220	2,20 m	1
			1258396260	2,60 m	
			1258396300	3,00 m	

\* Plaque de plâtre standard 12,5 mm / Standaard gipskartonplaat 12,5 mm

## JOUES DE FENÊTRE DAGKANT ELEMENTEN

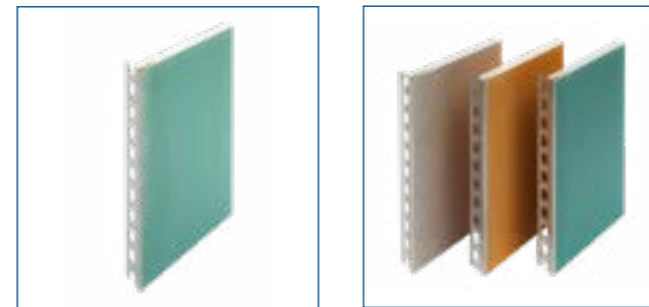

NOM NAAM	LARGEUR BREEDTE	STOCK STOCK	NR ARTICLE ARTIKEL NR	DIMENSION AFMETING	PIÈCES/EMB. STUKS/VERP.
JOUE DE FENÊTRE / DAGKANT ELEMENT WR (galva / verzinkt) *	1161	110 - 135 mm	1161110220	2,20 m	1
			1161110260	2,60 m	
			1161110300	3,00 m	
	1162	136 - 155 mm	1162136220	2,20 m	1
			1162136260	2,60 m	
			1162136300	3,00 m	
	1163	156 - 180 mm	1163156220	2,20 m	1
			1163156260	2,60 m	
			1163156300	3,00 m	
	1164	181 - 215 mm	1164181220	2,20 m	1
			1164181260	2,60 m	
			1164181300	3,00 m	
	1165	216 - 270 mm	1165216220	2,20 m	1
			1165216260	2,60 m	
			1165216300	3,00 m	
	1166	271 - 365 mm	1166271220	2,20 m	1
			1166271260	2,60 m	
			1166271300	3,00 m	
	1167	366 - 450 mm	1167366220	2,20 m	1
			1167366260	2,60 m	
			1167366300	3,00 m	

\* Plaque de plâtre WR verte 12,5 mm / WR gipskartonplaat groen 12,5 mm

## JOUES DE FENÊTRE DAGKANT ELEMENTEN

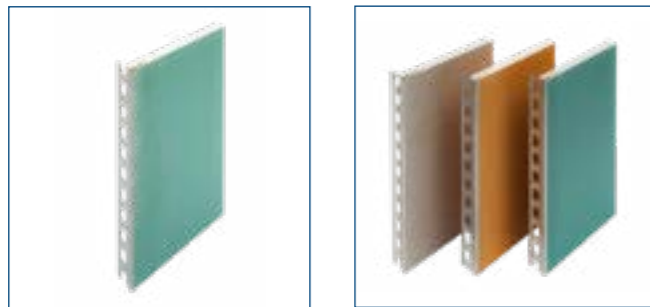

NOM NAAM	LARGEUR BREEDTE	STOCK STOCK	NR ARTICLE ARTIKEL NR	DIMENSION AFMETING	PIÈCES/EMB. STUKS/VERP.
JOUE DE FENÊTRE / DAGKANT ELEMENT WR (aluminium) *	1261	110 - 135 mm	1261110220	2,20 m	1
			1261110260	2,60 m	
			1261110300	3,00 m	
	1262	136 - 155 mm	1262136220	2,20 m	1
			1262136260	2,60 m	
			1262136300	3,00 m	
	1263	156 - 180 mm	1263156220	2,20 m	1
			1263156260	2,60 m	
			1263156300	3,00 m	
	1264	181 - 215 mm	1264181220	2,20 m	1
			1264181260	2,60 m	
			1264181300	3,00 m	
	1265	216 - 270 mm	1265216220	2,20 m	1
			1265216260	2,60 m	
			1265216300	3,00 m	
	1266	271 - 365 mm	1266271220	2,20 m	1
			1266271260	2,60 m	
			1266271300	3,00 m	
1267	366 - 450 mm	1267366220	2,20 m	1	
		1267366260	2,60 m		
		1267366300	3,00 m		

\* Plaque de plâtre WR verte 12,5 mm / WR gipskartonplaat groen 12,5 mm

## JOUES DE FENÊTRE DAGKANT ELEMENTEN

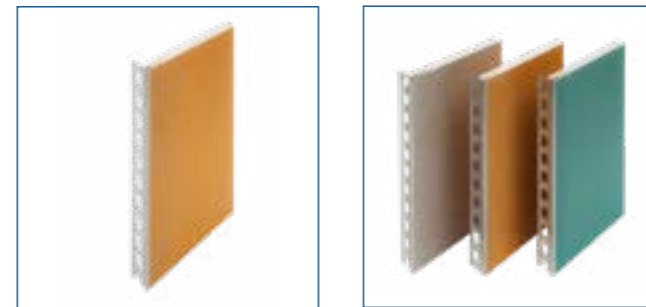

NOM NAAM	LARGEUR BREEDTE	STOCK STOCK	NR ARTICLE ARTIKEL NR	DIMENSION AFMETING	PIÈCES/EMB. STUKS/VERP.
JOUE DE FENÊTRE / DAGKANT ELEMENT WAB (galva / verzinkt) *	1171	110 - 135 mm	1171110220	2,20 m	1
			1171110260	2,60 m	
			1171110300	3,00 m	
	1172	136 - 155 mm	1172136220	2,20 m	1
			1172136260	2,60 m	
			1172136300	3,00 m	
	1173	156 - 180 mm	1173156220	2,20 m	1
			1173156260	2,60 m	
			1173156300	3,00 m	
	1174	181 - 215 mm	1174181220	2,20 m	1
			1174181260	2,60 m	
			1174181300	3,00 m	
	1175	216 - 270 mm	1175216220	2,20 m	1
			1175216260	2,60 m	
			1175216300	3,00 m	
	1176	271 - 365 mm	1176271220	2,20 m	1
			1176271260	2,60 m	
			1176271300	3,00 m	
1177	366 - 450 mm	1177366220	2,20 m	1	
		1177366260	2,60 m		
		1177366300	3,00 m		

\* Plaque de plâtre WAB orange 12,5 mm / WAB gipskartonplaat oranje 12,5 mm

## JOUES DE FENÊTRE DAGKANT ELEMENTEN

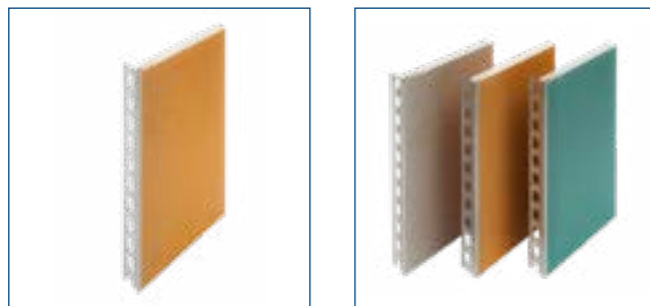

NOM NAAM	LARGEUR BREEDTE	STOCK STOCK	NR ARTICLE ARTIKEL NR	DIMENSION AFMETING	PIÈCES/EMB. STUKS/VERP.
JOUE DE FENÊTRE / DAGKANT ELEMENT WAB (aluminium) *	1271	110 - 135 mm	1271110220	2,20 m	1
			1271110260	2,60 m	
			1271110300	3,00 m	
	1272	136 - 155 mm	1272136220	2,20 m	1
			1272136260	2,60 m	
			1272136300	3,00 m	
	1273	156 - 180 mm	1273156220	2,20 m	1
			1273156260	2,60 m	
			1273156300	3,00 m	
	1274	181 - 215 mm	1274181220	2,20 m	1
			1274181260	2,60 m	
			1274181300	3,00 m	
	1275	216 - 270 mm	1275216220	2,20 m	1
			1275216260	2,60 m	
			1275216300	3,00 m	
	1276	271 - 365 mm	1276271220	2,20 m	1
			1276271260	2,60 m	
			1276271300	3,00 m	
1277	366 - 450 mm	1277366220	2,20 m	1	
		1277366260	2,60 m		
		1277366300	3,00 m		

\* Plaque de plâtre WAB orange 12,5 mm / WAB gipskartonplaat oranje 12,5 mm

## FIBRE DE VERRE GLASVEZEL



NOM NAAM	STOCK STOCK	NR ARTICLE ARTIKEL NR	DIMENSION AFMETING	PIÈCES/EMB. STUKS/VERP.	EMB./PAL. VERR./PAL.
JOINT TAPE BESTAPE	4090	S	4090090050	90 m X 50 mm	24 20



NOM NAAM	STOCK STOCK	NR ARTICLE ARTIKEL NR	DIMENSION AFMETING	PIÈCES/EMB. STUKS/VERP.	EMB./PAL. VERR./PAL.
FIBATAPE	4190	S	4190090100	90 m X 100 mm	6 40
	4820	S	4820020048	20 m X 48 mm	24 64
	4845		4845045048	45 m X 48 mm	24 40
	4890	S	4890090048	90 m X 48 mm	24 20



NOM NAAM	STOCK STOCK	NR ARTICLE ARTIKEL NR	DIMENSION AFMETING	PIÈCES/EMB. STUKS/VERP.	EMB./PAL. VERR./PAL.
FIBATAPE MOLD X10	4892		4892090048	90 m X 48 mm	12 40

## FIBRE DE VERRE GLASVEZEL



NOM NAAM	STOCK STOCK	NR ARTICLE ARTIKEL NR	DIMENSION AFMETING	PIÈCES/EMB. STUKS/VERP.	EMB./PAL. VERP./PAL.
FIBATAPE PERFECT FINISH	4894	4894090048	90 m X 48 mm	12	48

## ACCESSOIRES TOEBEHOREN



NOM NAAM	STOCK STOCK	NR ARTICLE ARTIKEL NR	DIMENSION AFMETING	PIÈCES/EMB. STUKS/VERP.	EMB./PAL. VERP./PAL.
PAPER JOINT TAPE	1022	S	1022020076	76 m X 5,2 cm	20 72



NOM NAAM	STOCK STOCK	NR ARTICLE ARTIKEL NR	DIMENSION AFMETING	PIÈCES/EMB. STUKS/VERP.	EMB./PAL. VERP./PAL.
QUICK STICK	1046		1046020076	76 m	20 30



NOM NAAM	STOCK STOCK	NR ARTICLE ARTIKEL NR	DIMENSION AFMETING	PIÈCES/EMB. STUKS/VERP.	EMB./PAL. VERP./PAL.
MICROFIX	1033	S	1033001000		1

## ACCESSOIRES TOEBEHOREN

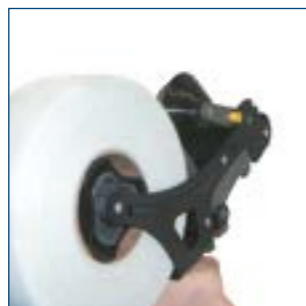

NOM NAAM	STOCK STOCK	NR ARTICLE ARTIKEL NR	DIMENSION AFMETING	PIÈCES/EMB. STUKS/VERP.	EMB./PAL. VERP./PAL.
FIBATAPE APPLICATOR	4846	S	4846001000	1	



NOM NAAM	STOCK STOCK	NR ARTICLE ARTIKEL NR	DIMENSION AFMETING	PIÈCES/EMB. STUKS/VERP.	EMB./PAL. VERP./PAL.
STRAITFLEX MUD-PRO2	1038		1038001000	1	



NOM NAAM	STOCK STOCK	NR ARTICLE ARTIKEL NR	DIMENSION AFMETING	PIÈCES/EMB. STUKS/VERP.	EMB./PAL. VERP./PAL.
STRAITFLEX ROLLER 300 MID FLEX	1039		1039001000	1	

## ACCESSOIRES TOEBEHOREN



NOM NAAM	STOCK STOCK	NR ARTICLE ARTIKEL NR	DIMENSION AFMETING	PIÈCES/EMB. STUKS/VERP.	EMB./PAL. VERP./PAL.
STRAITFLEX EXTENSION POLE	1040		1040001000	1	

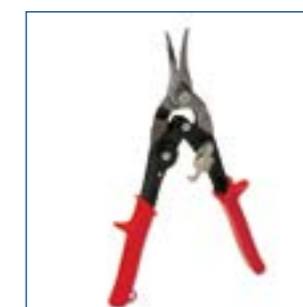
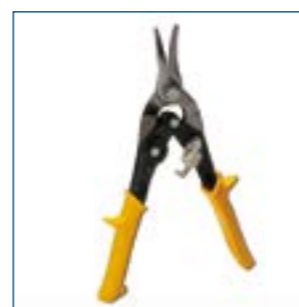

NOM NAAM	STOCK STOCK	NR ARTICLE ARTIKEL NR	DIMENSION AFMETING	PIÈCES/EMB. STUKS/VERP.	EMB./PAL. VERP./PAL.
PINCE POUR PROFILÉS / PROFIEL SCHAAR	1200		1200006000	6	
PINCE POUR PROFILÉS (vert - droitier) / PROFIEL SCHAAR (groen - rechtshandig)	1201		1201005000	5	
PINCE POUR PROFILÉS (rouge - gaucher) / PROFIEL SCHAAR (rood - linkshandig)	1202		1202005000	5	

## ACCESSOIRES TOEBEHOREN



NOM NAAM	STOCK STOCK	NR ARTICLE ARTIKEL NR	DIMENSION AFMETING	PIÈCES/EMB. STUKS/VERP.	EMB./PAL. VERP./PAL.
<b>PINCE MULTI COUP / MULTI COUP SCHAAR</b>	1205	1205001000		1	



NOM NAAM	STOCK STOCK	NR ARTICLE ARTIKEL NR	DIMENSION AFMETING	PIÈCES/EMB. STUKS/VERP.	EMB./PAL. VERP./PAL.
<b>CHEVILLES A FRAPPER (seau) / SLAGPLUGGEN (emmer)</b>	3049	3049300535	5/35 mm	1X3000	40
	3051	3051200640	6/40 mm	1X2000	40
	3054	3054150660	6/60 mm	1X1500	40

## ACCESSOIRES TOEBEHOREN



NOM NAAM	STOCK STOCK	NR ARTICLE ARTIKEL NR	DIMENSION AFMETING	PIÈCES/EMB. STUKS/VERP.	EMB./PAL. VERP./PAL.
<b>CHEVILLES A FRAPPER / SLAGPLUGGEN</b>	3050	3050615640	6/40 mm	6x150	48
	3053	3053610660	6/60 mm	6x100	48
	3055	3055810860	8/60 mm	8x100	48
	3056	3056710880	8/80 mm	7x100	48



## PROFILÉS MDB STUDS MDB STUDS PROFIELEN

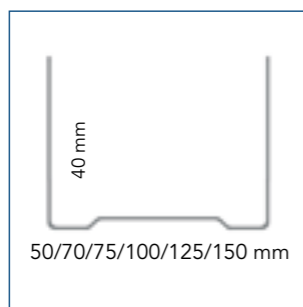

NOM NAAM		STOCK STOCK	NR ARTICLE ARTIKEL NR	DIMENSION AFMETING	PIÈCES/EMB. STUKS/VERP.	ML/EMB. LM/VERP.	EMB./PAL. VERP./PAL.	ML/PAL. LM/PAL.	
PROFILS U HORIZONTALAUX / U - HORIZONTALE PROFIELEN	U 50/40	3000	S	3000008400	4,00 m	8	32,00	45	1440
	U 70/40	3070		3070008400	4,00 m	8	32,00	36	1152
	U 75/40	3001	S	3001008400	4,00 m	8	32,00	36	1152
	U 100/40	3002		3002008400	4,00 m	8	32,00	24	768
	U 125/40	3003		3003008400	4,00 m	8	32,00	18	576
	U 150/40	3004		3004008400	4,00 m	8	32,00	18	576

Ép./Dikte 0,6 mm // Commande min. 1 pal. / Min. bestelling 1 pal.

## PROFILÉS MDB STUDS MDB STUDS PROFIELEN

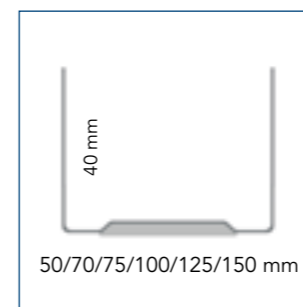

NOM NAAM		STOCK STOCK	NR ARTICLE ARTIKEL NR	DIMENSION AFMETING	PIÈCES/EMB. STUKS/VERP.	ML/EMB. LM/VERP.	EMB./PAL. VERP./PAL.	ML/PAL. LM/PAL.	
PROFILS U HORIZONTALAUX / U - HORIZONTALE PROFIELEN	U 50/40 + FOAM	3005		3005008400	4,00 m	8	32,00	45	1440
	U 70/40 + FOAM	3014		3014008400	4,00 m	8	32,00	36	1152
	U 75/40 + FOAM	3006		3006008400	4,00 m	8	32,00	36	1152
	U 100/40 + FOAM	3007		3007008400	4,00 m	8	32,00	24	768
	U 125/40 + FOAM	3008		3008008400	4,00 m	8	32,00	18	576
	U 150/40 + FOAM	3009		3009008400	4,00 m	8	32,00	18	576

Ép./Dikte 0,6 mm // Commande min. 1 pal. / Min. bestelling 1 pal.

## PROFILÉS MDB STUDS MDB STUDS PROFIELEN

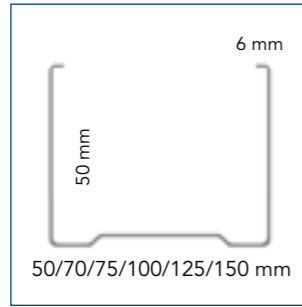

NOM NAAM		STOCK STOCK	NR ARTICLE ARTIKEL NR	DIMENSION AFMETING	PIÈCES/EMB. STUKS/VERP.	ML/EMB. LM/VERP.	EMB./PAL. VERP./PAL.	ML/PAL. LM/PAL.	
PROFILS C VERTICAUX / C - VERTICALE PROFIELEN	C 50/50	3010		3010008240	2,40 m	8	19,20	35	672
			S	3010008260	2,60 m	8	20,80	35	728
			S	3010008280	2,80 m	8	22,40	35	784
			S	3010008300	3,00 m	8	24,00	35	840
				3010008320	3,20 m	8	25,60	35	896
			S	3010008360	3,60 m	8	28,80	35	1008
			S	3010008400	4,00 m	8	32,00	35	1120
	C 70/50	3097		3097008260	2,60 m	8	20,80	25	520
				3097008280	2,80 m	8	22,40	25	560
				3097008300	3,00 m	8	24,00	25	600
				3097008320	3,20 m	8	25,60	25	640
				3097008360	3,60 m	8	28,80	25	720
				3097008400	4,00 m	8	32,00	25	800
	C 75/50	3015	S	3015008260	2,60 m	8	20,80	25	520
				3015008280	2,80 m	8	22,40	25	560
			S	3015008300	3,00 m	8	24,00	25	600
				3015008320	3,20 m	8	25,60	25	640
				3015008360	3,60 m	8	28,80	25	720
				3015008400	4,00 m	8	32,00	25	800
				3015008450	4,50 m	8	36,00	25	900
		3015008500	5,00 m	8	40,00	25	1000		
	C 100/50	3016		3016008260	2,60 m	8	20,80	20	416
				3016008280	2,80 m	8	22,40	20	448
				3016008300	3,00 m	8	24,00	20	480
			3016008320	3,20 m	8	25,60	20	512	
			3016008360	3,60 m	8	28,80	20	576	
			3016008400	4,00 m	8	32,00	20	640	
			3016008450	4,50 m	8	36,00	20	720	
	3016008500	5,00 m	8	40,00	20	800			

Ép./Dikte 0,6 mm // Commande min. 1 pal. / Min. bestelling 1 pal.

## PROFILÉS MDB STUDS MDB STUDS PROFIELEN

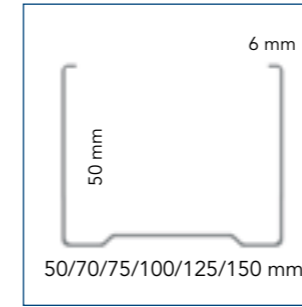
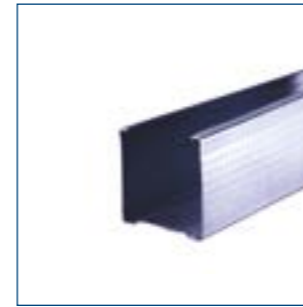

NOM NAAM		STOCK STOCK	NR ARTICLE ARTIKEL NR	DIMENSION AFMETING	PIÈCES/EMB. STUKS/VERP.	ML/EMB. LM/VERP.	EMB./PAL. VERP./PAL.	ML/PAL. LM/PAL.	
PROFILS C VERTICAUX / C - VERTICALE PROFIELEN	C 125/50	3098		3098008450	4,50 m	8	36,00	15	540
				3098008500	5,00 m	8	40,00	15	600
	C 150/50	3099		3099008450	4,50 m	8	36,00	15	540
				3099008500	5,00 m	8	40,00	15	600

Ép./Dikte 0,6 mm // Commande min. 1 pal. / Min. bestelling 1 pal.

## PROFILÉS MDB STUDS MDB STUDS PROFIELEN

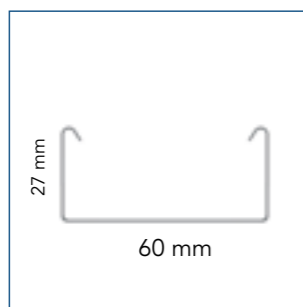

NOM NAAM		STOCK STOCK	NR ARTICLE ARTIKEL NR	DIMENSION AFMETING	PIÈCES/EMB. STUKS/VERP.	ML/EMB. LM/VERP.	EMB./PAL. VERP./PAL.	ML/PAL. LM/PAL.	
PROFILS C POUR PLAFONDS / C - PLAFOND-PROFIELEN	C 60/27	3019	S	3019008400	4,00 m	10	40,00	42	1680

Ép./dikte 0,6 mm // Commande min. 1 pal. / Min. bestelling 1 pal.

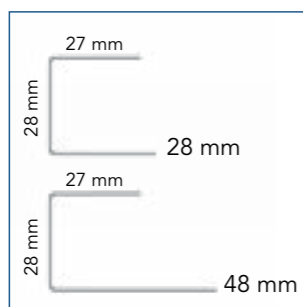

NOM NAAM		STOCK STOCK	NR ARTICLE ARTIKEL NR	DIMENSION AFMETING	PIÈCES/EMB. STUKS/VERP.	ML/EMB. LM/VERP.	EMB./PAL. VERP./PAL.	ML/PAL. LM/PAL.	
PROFILS U POUR PLAFONDS / U - PLAFOND-PROFIELEN	U 27/28	3020	S	3020008300	3,00 m	10	30,00	42	1260
			S	3020008400	4,00 m	10	40,00	42	1680
	U 27/48	3022	S	3022008400	4,00 m	10	40,00	42	1680

Ép./Dikte 0,6 mm // Commande min. 1 pal. / Min. bestelling 1 pal.

## ACCESSOIRES MDB STUDS MDB STUDS TOEBEHOREN



NOM NAAM		STOCK STOCK	NR ARTICLE ARTIKEL NR	DIMENSION AFMETING	PIÈCES/EMB. STUKS/VERP.	EMB./PAL. VERP./PAL.
PINCE À SERTIR / VERBIDINGS-TANG METAL STUDS	1209		1209001000		1	



NOM NAAM		STOCK STOCK	NR ARTICLE ARTIKEL NR	DIMENSION AFMETING	PIÈCES/EMB. STUKS/VERP.	EMB./PAL. VERP./PAL.
RACCORD EN CROIX (plié) / KRUIS-VERBINDER (geplooid)	3013	S	3013100627		100	170
RACCORD EN CROIX (à plier) / KRUIS-VERBINDER (te plooiën)	3029	S	3029100000		100	170

## ACCESSOIRES MDB STUDS MDB STUDS TOEBEHOREN

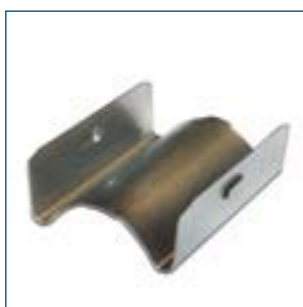

NOM NAAM	STOCK STOCK	NR ARTICLE ARTIKEL NR	DIMENSION AFMETING	PIÈCES/EMB. STUKS/VERP.	EMB./PAL. VERP./PAL.
RACCORD EN LONGUEUR / VERBINDINGS- STUK VOOR PLAFOND- PROFIELEN	3030 S	3030100000	80 mm	100	66



NOM NAAM	STOCK STOCK	NR ARTICLE ARTIKEL NR	DIMENSION AFMETING	PIÈCES/EMB. STUKS/VERP.	EMB./PAL. VERP./PAL.
SUSPENTE SUR BOIS / DIRECT HANGER	3044	3044100060	60 mm	100	260
	3045 S	3045100125	125 mm	100	170
	3046 S	3046100200	200 mm	100	66

## ACCESSOIRES MDB STUDS MDB STUDS TOEBEHOREN



NOM NAAM	STOCK STOCK	NR ARTICLE ARTIKEL NR	DIMENSION AFMETING	PIÈCES/EMB. STUKS/VERP.	EMB./PAL. VERP./PAL.
SUSPENTE PLATE POUR STRUCTURE BOIS / VLAkke OPHANGER VOOR HOUTEN STRUCTUUR	3038	3038100090	90 mm	100	220
	3034 S	3034100170	170 mm	100	350
	3043 S	3043100270	270 mm	100	220



NOM NAAM	STOCK STOCK	NR ARTICLE ARTIKEL NR	DIMENSION AFMETING	PIÈCES/EMB. STUKS/VERP.	EMB./PAL. VERP./PAL.
SUSPENSION RAPIDE ROTATIVE / DRAAIENDE SNELSPANCLIP*	3035 S	3035100000		100	48

\* Pour plafond < à 25 kg/m<sup>2</sup> / Voor plafond < 25 kg/m<sup>2</sup>

## ACCESSOIRES MDB STUDS MDB STUDS TOEBEHOREN



NOM NAAM	STOCK STOCK	NR ARTICLE ARTIKEL NR	DIMENSION AFMETING	PIÈCES/EMB. STUKS/VERP.	EMB./PAL. VERP./PAL.
SUSPENTE DOUBLE FIL NON MONTÉE / DUBBEL VEER	3036	3036100000		100	



NOM NAAM	STOCK STOCK	NR ARTICLE ARTIKEL NR	DIMENSION AFMETING	PIÈCES/EMB. STUKS/VERP.	EMB./PAL. VERP./PAL.
SUSPENTE DOUBLE MONTÉE + FILS / DUBBEL VEER MET DRADEN	3037	3037100360	30/60 mm	100	32
	3037	3037100610	60/100 mm	100	24

## ACCESSOIRES MDB STUDS MDB STUDS TOEBEHOREN



NOM NAAM	STOCK STOCK	NR ARTICLE ARTIKEL NR	DIMENSION AFMETING	PIÈCES/EMB. STUKS/VERP.	EMB./PAL. VERP./PAL.
TIGE LISSE SANS CÉILLET / DRAAD ZONDER OOG	3040	S	3040100300	3000 mm	100



NOM NAAM	STOCK STOCK	NR ARTICLE ARTIKEL NR	DIMENSION AFMETING	PIÈCES/EMB. STUKS/VERP.	EMB./PAL. VERP./PAL.
FIL À CÉILLET / AFHANG- DRAAD MET OOG	3041	S	3041100012	125 mm	100
		S	3041100025	250 mm	100
		S	3041100037	375 mm	100
		S	3041100050	500 mm	100
		S	3041100075	750 mm	100
		S	3041100100	1000 mm	100
			3041100125	1250 mm	100
			3041100150	1500 mm	100
			3041100175	1750 mm	100
			3041100200	2000 mm	100

## ACCESSOIRES MDB STUDS MDB STUDS TOEBEHOREN



NOM NAAM	STOCK STOCK	NR ARTICLE ARTIKEL NR	DIMENSION AFMETING	PIÈCES/EMB. STUKS/VERP.	EMB./PAL. VERP./PAL.
MS CLIPS / VOEGEN CLIPS	3061	S	3061100000	100	264



NOM NAAM	STOCK STOCK	NR ARTICLE ARTIKEL NR	DIMENSION AFMETING	PIÈCES/EMB. STUKS/VERP.	EMB./PAL. VERP./PAL.
NONIUS SUSPENTE SUPÉRIEURE / NONIUS BOVEN- HANGER	3081		3081100014	140 mm	100
	3083		3083100034	340 mm	100
	3084		3084100044	440 mm	100
	3085		3085100054	540 mm	100
	3086		3086100064	640 mm	100
	3087		3087100074	740 mm	100
	3088		3088100084	840 mm	100
	3089		3089100094	940 mm	100
	3090		3090100114	1140 mm	100
	3091		3091100134	1340 mm	100

## ACCESSOIRES MDB STUDS MDB STUDS TOEBEHOREN



NOM NAAM	STOCK STOCK	NR ARTICLE ARTIKEL NR	DIMENSION AFMETING	PIÈCES/EMB. STUKS/VERP.	EMB./PAL. VERP./PAL.
NONIUS ÉPINGLE / VEERKLEM VOOR NONIUS	3092		3092100072	72 mm	100



NOM NAAM	STOCK STOCK	NR ARTICLE ARTIKEL NR	DIMENSION AFMETING	PIÈCES/EMB. STUKS/VERP.	EMB./PAL. VERP./PAL.
NONIUS SUSPENTE INFÉRIEURE / NONIUS ONDERDEEL HANGER*	3093		3093100130	130 mm	100

\* Pour plafond > à 25 kg/m<sup>2</sup> / Voor plafond > 25 kg/m<sup>2</sup>

## ACCESSOIRES MDB STUDS MDB STUDS TOEBEHOREN



NOM NAAM	STOCK STOCK	NR ARTICLE ARTIKEL NR	DIMENSION AFMETING	PIÈCES/EMB. STUKS/VERP.	EMB./PAL. VERP./PAL.
CHEVILLE EXPRESS POUR PLAFOND / EXPRESS PLAFONDPLUG	3052	3052500820		2 X 250	



NOM NAAM	STOCK STOCK	NR ARTICLE ARTIKEL NR	DIMENSION AFMETING	PIÈCES/EMB. STUKS/VERP.	EMB./PAL. VERP./PAL.
STUDS FOAM	3074	3074102532	25 mm X 10 m	32	

## ENDUITS INTÉRIEURS BINNENBEPLEISTERING

## PROFILÉS D'ANGLE HOEKPROFIELEN

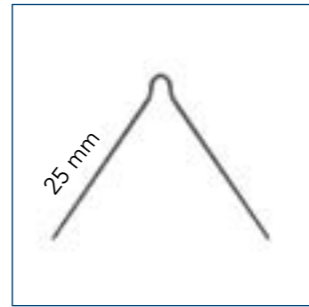
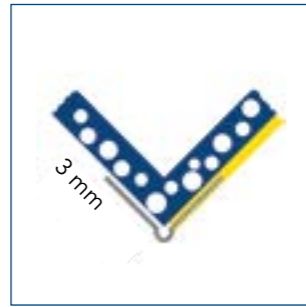

NOM NAAM	EP. D'ENDUIT PLEISTERDIKTE	STOCK STOCK	NR ARTICLE ARTIKEL NR	DIMENSION AFMETING	PIÈCES/EMB. STUKS/VERP.	ML/EMB. LM/VERP.	EMB./PAL. VERP./PAL.	
MINIGYP	0110	3 mm	S	0110025260	2,60 m	25	65,00	160
	0111	3 mm	S	0111025260	2,60 m	25	65,00	160
	0111	3 mm	S	0111025300	3,00 m	25	75,00	160
MINIGYP ALU	0211	3 mm	S	0211025260	2,60 m	25	65,00	160
MINIGYP INOX	0411	3 mm	S	0411025250	2,50 m	25	62,50	160
	0411	3 mm	S	0411025300	3,00 m	25	75,00	160

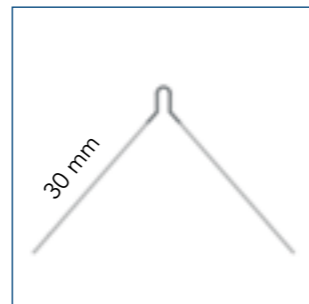
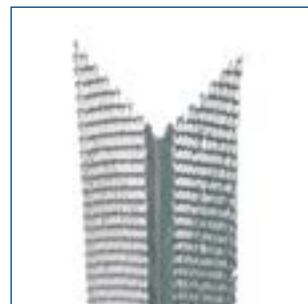

NOM NAAM	EP. D'ENDUIT PLEISTERDIKTE	STOCK STOCK	NR ARTICLE ARTIKEL NR	DIMENSION AFMETING	PIÈCES/EMB. STUKS/VERP.	ML/EMB. LM/VERP.	EMB./PAL. VERP./PAL.	
MINIMESH	0131	3 mm	S	0131025260	2,60 m	25	65,00	150
	0131	3 mm	S	0131025300	3,00 m	25	75,00	150

## PROFILÉS D'ANGLE HOEKPROFIELEN

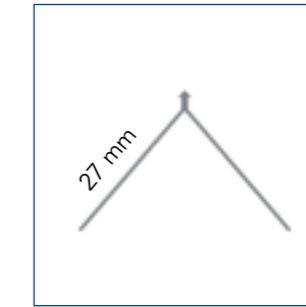
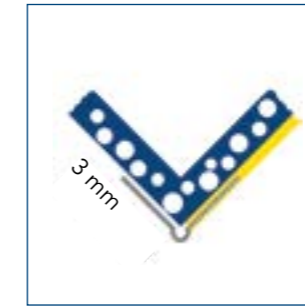
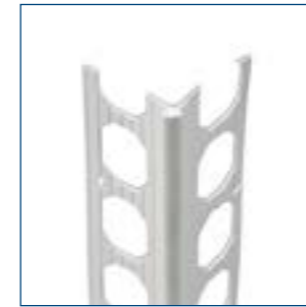

NOM NAAM	EP. D'ENDUIT PLEISTERDIKTE	STOCK STOCK	NR ARTICLE ARTIKEL NR	DIMENSION AFMETING	PIÈCES/EMB. STUKS/VERP.	ML/EMB. LM/VERP.	EMB./PAL. VERP./PAL.	
<b>CORNER BEAD PVC</b>	8003	3 mm		8003025250	2,50 m	25	62,50	40

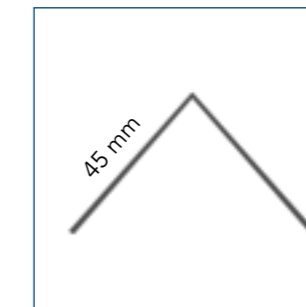
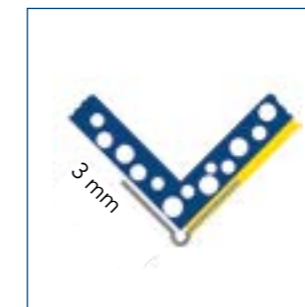

NOM NAAM	EP. D'ENDUIT PLEISTERDIKTE	STOCK STOCK	NR ARTICLE ARTIKEL NR	DIMENSION AFMETING	PIÈCES/EMB. STUKS/VERP.	ML/EMB. LM/VERP.	EMB./PAL. VERP./PAL.	
<b>CORNER BEAD PVC ECO</b>	8403	3 mm		8403070270	2,70 m	70	189,00	40

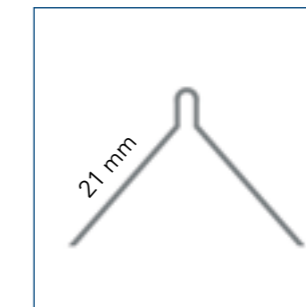

NOM NAAM	EP. D'ENDUIT PLEISTERDIKTE	STOCK STOCK	NR ARTICLE ARTIKEL NR	DIMENSION AFMETING	PIÈCES/EMB. STUKS/VERP.	ML/EMB. LM/VERP.	EMB./PAL. VERP./PAL.	
<b>CORNER BEAD PVC</b>	8066	6 mm		8066025250	2,50 m	25	62,50	40



## PROFILÉS D'ANGLE HOEKPROFIELEN

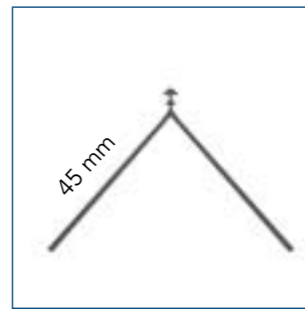

NOM NAAM	EP. D'ENDUIT PLEISTERDIKTE	STOCK STOCK	NR ARTICLE ARTIKEL NR	DIMENSION AFMETING	PIÈCES/EMB. STUKS/VERP.	ML/EMB. LM/VERP.	EMB./PAL. VERP./PAL.
<b>CORNER BEAD PVC ECO</b> 8406	6 mm		8406025270	2,70 m	25	67,50	40

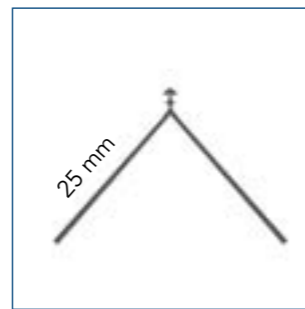

NOM NAAM	EP. D'ENDUIT PLEISTERDIKTE	STOCK STOCK	NR ARTICLE ARTIKEL NR	DIMENSION AFMETING	PIÈCES/EMB. STUKS/VERP.	ML/EMB. LM/VERP.	EMB./PAL. VERP./PAL.
<b>CORNER BEAD PVC ECO INTER</b> 8466	6 mm		8466040250	2,50	40	100,00	40

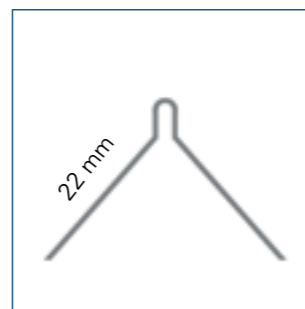
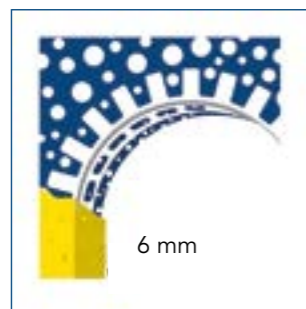

NOM NAAM	EP. D'ENDUIT PLEISTERDIKTE	STOCK STOCK	NR ARTICLE ARTIKEL NR	DIMENSION AFMETING	PIÈCES/EMB. STUKS/VERP.	ML/EMB. LM/VERP.	EMB./PAL. VERP./PAL.
<b>RONDO PVC GYP PVC</b> 8207	6 mm	S	8207050300	3,00 m	50	150,00	40

## PROFILÉS D'ANGLE HOEKPROFIELEN

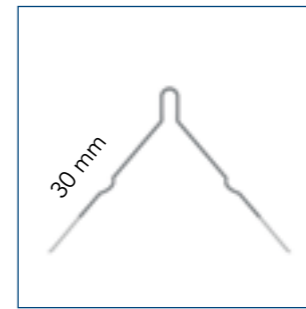
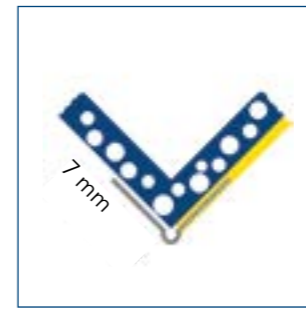

NOM NAAM	EP. D'ENDUIT PLEISTERDIKTE	STOCK STOCK	NR ARTICLE ARTIKEL NR	DIMENSION AFMETING	PIÈCES/EMB. STUKS/VERP.	ML/EMB. LM/VERP.	EMB./PAL. VERP./PAL.
PERFOR	0112	7 mm	0112100150	1,50 m	100	150,00	40
	0112	7 mm	0112100180	1,80 m	100	180,00	40
	0112	7 mm	0112100200	2,00 m	100	200,00	40
	0112	7 mm	0112100220	2,20 m	100	220,00	40
	0112	7 mm	0112100250	2,50 m	100	250,00	40
	0112	7 mm	0112100260	2,60 m	100	260,00	40
	0112	7 mm	0112100270	2,70 m	100	270,00	40
	0112	7 mm	0112100280	2,80 m	100	280,00	40
	0112	7 mm	0112100300	3,00 m	100	300,00	40
PERALU	0212	7 mm	0212100150	1,50 m	100	150,00	40
	0212	7 mm	0212100180	1,80 m	100	180,00	40
	0212	7 mm	0212100200	2,00 m	100	200,00	40
	0212	7 mm	0212100220	2,20 m	100	220,00	40
	0212	7 mm	0212100250	2,50 m	100	250,00	40
	0212	7 mm	0212100260	2,60 m	100	260,00	40
	0212	7 mm	0212100270	2,70 m	100	270,00	40
	0212	7 mm	0212100280	2,80 m	100	280,00	40
	0212	7 mm	0212100300	3,00 m	100	300,00	40

## PROFILÉS D'ANGLE HOEKPROFIELEN

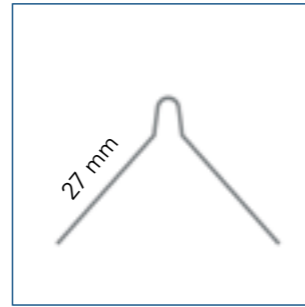
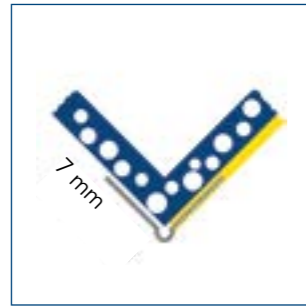

NOM NAAM	EP. D'ENDUIT PLEISTERDIKTE	STOCK STOCK	NR ARTICLE ARTIKEL NR	DIMENSION AFMETING	PIÈCES/EMB. STUKS/VERP.	ML/EMB. LM/VERP.	EMB./PAL. VERP./PAL.	
PERGYPLUS	0132	7 mm	S	0132020150	1,50 m	20	30,00	200
	0132	7 mm	S	0132020180	1,80 m	20	36,00	200
	0132	7 mm	S	0132020200	2,00 m	20	40,00	200
	0132	7 mm	S	0132020220	2,20 m	20	44,00	200
	0132	7 mm	S	0132020240	2,40 m	20	48,00	200
	0132	7 mm	S	0132020250	2,50 m	20	50,00	200
	0132	7 mm	S	0132020260	2,60 m	20	52,00	200
	0132	7 mm	S	0132020270	2,70 m	20	54,00	200
	0132	7 mm	S	0132020280	2,80 m	20	56,00	200
	0132	7 mm	S	0132020300	3,00 m	20	60,00	200
	0132	7 mm	S	0132020350	3,50 m	20	70,00	200

## PROFILÉS D'ANGLE HOEKPROFIELEN

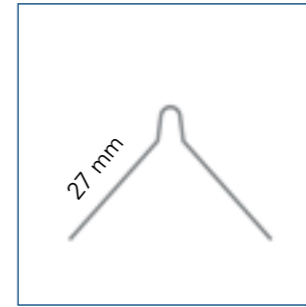
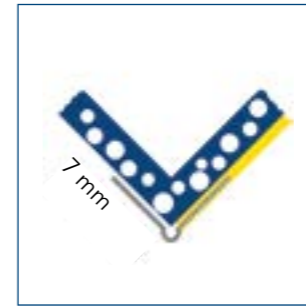

NOM NAAM	EP. D'ENDUIT PLEISTERDIKTE	STOCK STOCK	NR ARTICLE ARTIKEL NR	DIMENSION AFMETING	PIÈCES/EMB. STUKS/VERP.	ML/EMB. LM/VERP.	EMB./PAL. VERP./PAL.	
PERCAR	0138	7 mm	S	0138020150	1,50 m	20	30,00	200
	0138	7 mm	S	0138020180	1,80 m	20	36,00	200
	0138	7 mm	S	0138020200	2,00 m	20	40,00	200
	0138	7 mm	S	0138020220	2,20 m	20	44,00	200
	0138	7 mm	S	0138020250	2,50 m	20	50,00	200
	0138	7 mm	S	0138020260	2,60 m	20	52,00	200
	0138	7 mm	S	0138020270	2,70 m	20	54,00	200
	0138	7 mm	S	0138020280	2,80 m	20	56,00	200
	0138	7 mm	S	0138020300	3,00 m	20	60,00	200
	PERCAR ALU	0238	7 mm	S	0238020150	1,50 m	20	30,00
0238		7 mm	S	0238020180	1,80 m	20	36,00	200
0238		7 mm	S	0238020200	2,00 m	20	40,00	200
0238		7 mm	S	0238020220	2,20 m	20	44,00	200
0238		7 mm	S	0238020250	2,50 m	20	50,00	200
0238		7 mm	S	0238020260	2,60 m	20	52,00	200
0238		7 mm	S	0238020270	2,70 m	20	54,00	200
0238		7 mm	S	0238020280	2,80 m	20	56,00	200
0238		7 mm	S	0238020300	3,00 m	20	60,00	200
PERCAR INOX	0438	7 mm	S	0438020260	2,60 m	20	52,00	200
	0438	7 mm	S	0438020300	3,00 m	20	60,00	200

## PROFILÉS D'ANGLE HOEKPROFIELEN

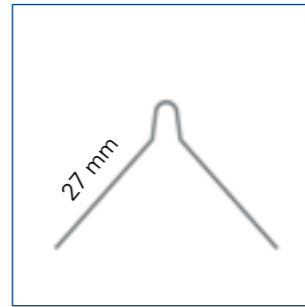
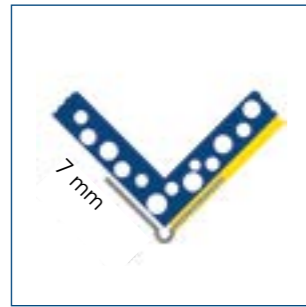

NOM NAAM	EP. D'ENDUIT PLEISTERDIKTE	STOCK STOCK	NR ARTICLE ARTIKEL NR	DIMENSION AFMETING	PIÈCES/EMB. STUKS/VERP.	ML/EMB. LM/VERP.	EMB./PAL. VERP./PAL.	
PERCAR	0139	7 mm	S	0139025150	1,50 m	25	37,50	160
	0139	7 mm	S	0139025180	1,80 m	25	45,00	160
	0139	7 mm	S	0139025200	2,00 m	25	50,00	160
	0139	7 mm	S	0139025220	2,20 m	25	55,00	160
	0139	7 mm	S	0139025250	2,50 m	25	62,50	160
	0139	7 mm	S	0139025260	2,60 m	25	65,00	160
	0139	7 mm	S	0139025270	2,70 m	25	67,50	160
	0139	7 mm	S	0139025280	2,80 m	25	70,00	160
	0139	7 mm	S	0139025300	3,00 m	25	75,00	160

## PROFILÉS D'ANGLE HOEKPROFIELEN

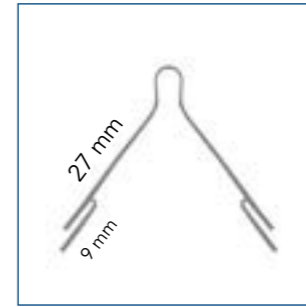
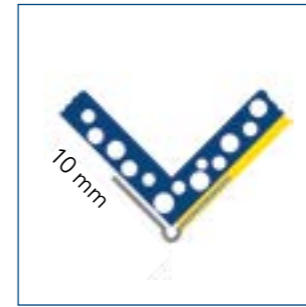

NOM NAAM	EP. D'ENDUIT PLEISTERDIKTE	STOCK STOCK	NR ARTICLE ARTIKEL NR	DIMENSION AFMETING	PIÈCES/EMB. STUKS/VERP.	ML/EMB. LM/VERP.	EMB./PAL. VERP./PAL.	
CORNER	0013	10 mm		0013015300	3,00 m	15	45,00	120

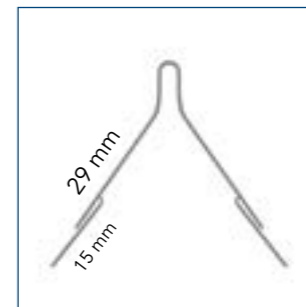
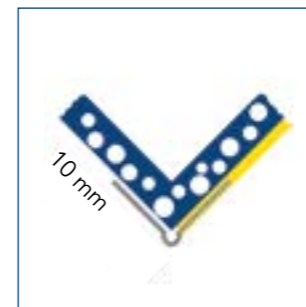

NOM NAAM	EP. D'ENDUIT PLEISTERDIKTE	STOCK STOCK	NR ARTICLE ARTIKEL NR	DIMENSION AFMETING	PIÈCES/EMB. STUKS/VERP.	ML/EMB. LM/VERP.	EMB./PAL. VERP./PAL.	
CORNER	0015	10 mm		0015015300	3,00 m	15	45,00	100

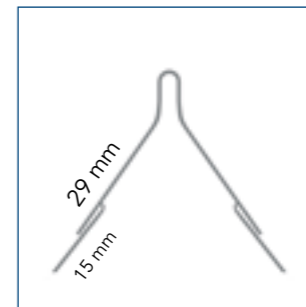
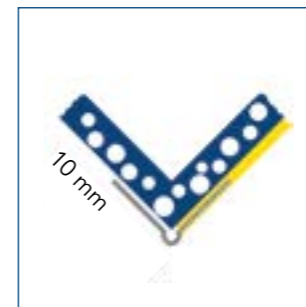

NOM NAAM	EP. D'ENDUIT PLEISTERDIKTE	STOCK STOCK	NR ARTICLE ARTIKEL NR	DIMENSION AFMETING	PIÈCES/EMB. STUKS/VERP.	ML/EMB. LM/VERP.	EMB./PAL. VERP./PAL.	
CORNER ALU	0214	10 mm	S	0214025300	3,00 m	25	75,00	80

## PROFILÉS D'ANGLE HOEKPROFIELEN

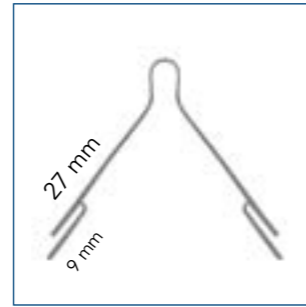
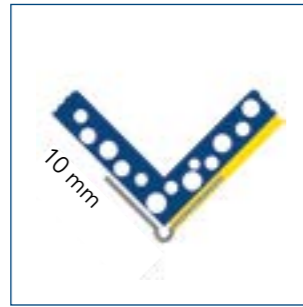

NOM NAAM	EP. D'ENDUIT PLEISTERDIKTE	STOCK STOCK	NR ARTICLE ARTIKEL NR	DIMENSION AFMETING	PIÈCES/EMB. STUKS/VERP.	ML/EMB. LM/VERP.	EMB./PAL. VERP./PAL.	
CORNER INOX	0413	10 mm	S	0413015250	2,50 m	15	37,50	100
	0413	10 mm	S	0413015300	3,00 m	15	45,00	100

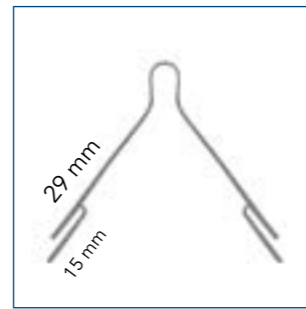

NOM NAAM	EP. D'ENDUIT PLEISTERDIKTE	STOCK STOCK	NR ARTICLE ARTIKEL NR	DIMENSION AFMETING	PIÈCES/EMB. STUKS/VERP.	ML/EMB. LM/VERP.	EMB./PAL. VERP./PAL.	
CORNER INOX	0415	10 mm	S	0415015250	2,50 m	15	37,50	100
	0415	10 mm	S	0415015300	3,00 m	15	45,00	100

## PROFILÉS D'ANGLE HOEKPROFIELEN

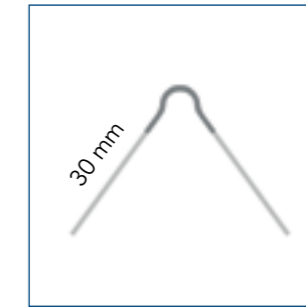
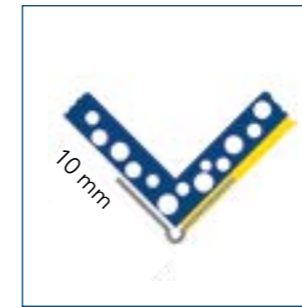
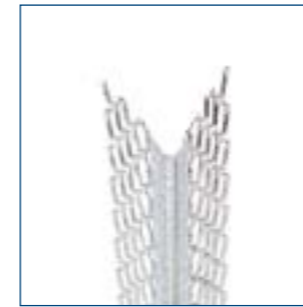

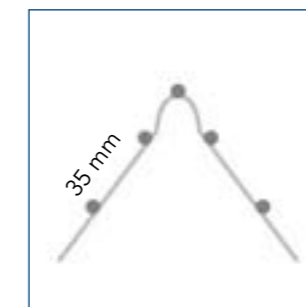
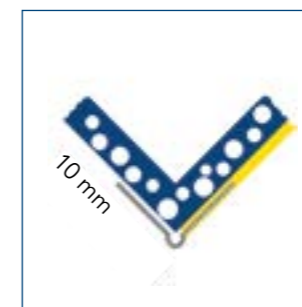
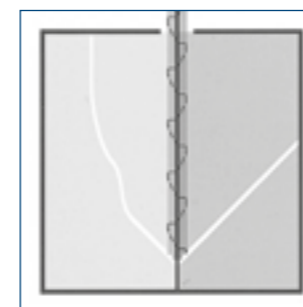

NOM NAAM	EP. D'ENDUIT PLEISTERDIKTE	STOCK STOCK	NR ARTICLE ARTIKEL NR	DIMENSION AFMETING	PIÈCES/EMB. STUKS/VERP.	ML/EMB. LM/VERP.	EMB./PAL. VERP./PAL.	
ANGLEX	0119	10 mm		0119025135	1,35 m	25	33,75	160
	0119	10 mm	S	0119025150	1,50 m	25	37,50	160
	0119	10 mm	S	0119025200	2,00 m	25	50,00	160
	0119	10 mm	S	0119025225	2,25 m	25	56,25	160
	0119	10 mm	S	0119025250	2,50 m	25	62,50	160
	0119	10 mm	S	0119025260	2,60 m	25	65,00	160
	0119	10 mm	S	0119025275	2,75 m	25	68,75	160
	0119	10 mm	S	0119025300	3,00 m	25	75,00	160
ANGLALU	0219	10 mm	S	0219025250	2,50 m	25	62,50	160
	0219	10 mm	S	0219025300	3,00 m	25	75,00	160
ANGLINOX	0419	10 mm	S	0419025250	2,50 m	25	62,50	160
	0419	10 mm		0419025260	2,60 m	25	65,00	160
	0419	10 mm		0419025300	3,00 m	25	75,00	160





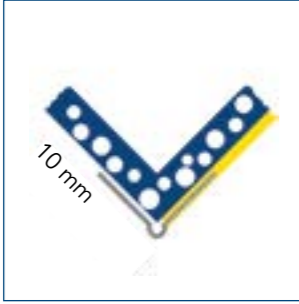
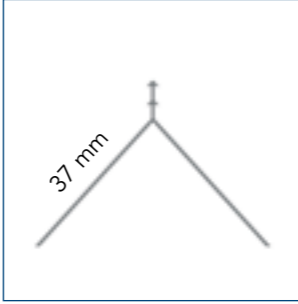

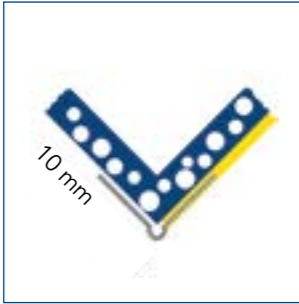
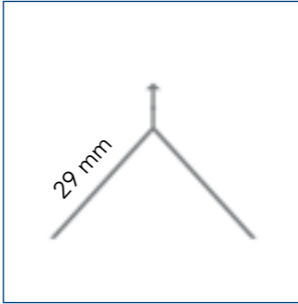
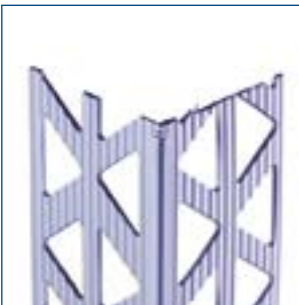
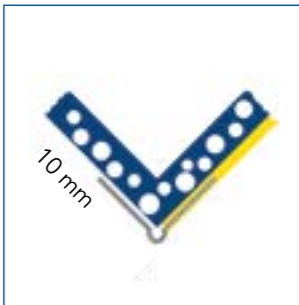
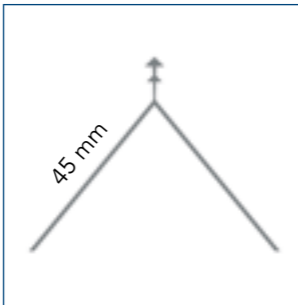
NOM NAAM	EP. D'ENDUIT PLEISTERDIKTE	STOCK STOCK	NR ARTICLE ARTIKEL NR	DIMENSION AFMETING	PIÈCES/EMB. STUKS/VERP.	ML/EMB. LM/VERP.	EMB./PAL. VERP./PAL.	
WIDRA IP	0182	10 mm		0182040295	2,95 m	40	118,00	48
WIDRA IPE	0429	10 mm		0429040295	2,95 m	40	118,00	24

## PROFILÉS D'ANGLE HOEKPROFIELEN

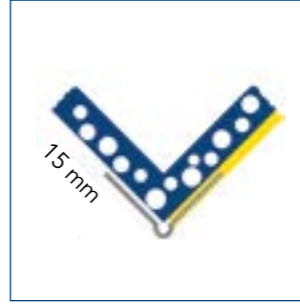
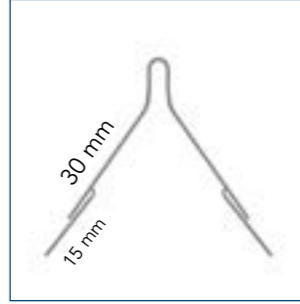
							
<b>CORNER BEAD PVC</b> 8010	10 mm	S	8010025250	2,50 m	25	62,50	40
							
<b>CORNER BEAD PVC</b> 8011	10 mm	S	8011025250	2,50 m	25	62,50	40
							
<b>CORNER BEAD PVC ECO</b> 8410	10 mm		8410025270	2,70 m	25	67,50	40

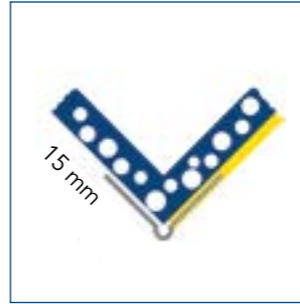
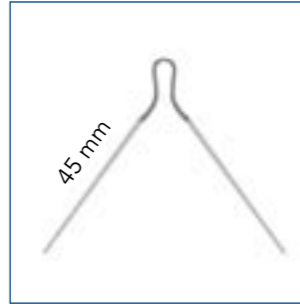
## PROFILÉS D'ANGLE HOEKPROFIELEN

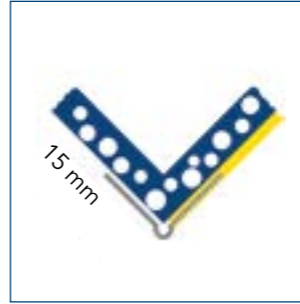
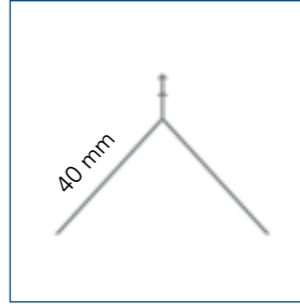
							
<b>CORNER</b> 0014	15 mm	S	0014015300	3,00 m	15	45,00	100
							
<b>SUPLEX</b> 0118	15 mm	S	0118015300	3,00 m	15	45,00	100
<b>SUPLEX INOX</b> 0418	15 mm	S	0418015300	3,00 m	15	45,00	100
							
<b>CORNER BEAD PVC</b> 8015	15 mm	S	8015025250	2,50 m	25	62,50	40

## PROFILÉS D'ARRÊT STOP- & AFWERKPROFIELEN

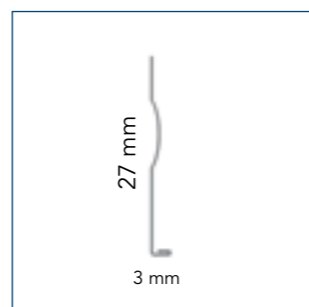
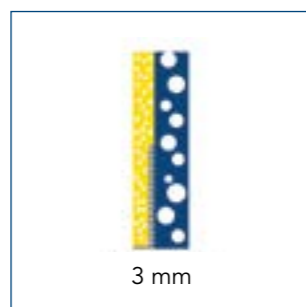

NOM NAAM	EP. D'ENDUIT PLEISTERDIKTE	STOCK STOCK	NR ARTICLE ARTIKEL NR	DIMENSION AFMETING	PIÈCES/EMB. STUKS/VERP.	ML/EMB. LM/VERP.	EMB./PAL. VERP./PAL.	
GALSTOP	0120	3 mm	S	0120025250	2,50 m	25	62,50	120
	0120	3 mm	S	0120025300	3,00 m	25	75,00	120
ALUSTOP	0220	3 mm	S	0220025250	2,50 m	25	62,50	160
	0220	3 mm	S	0220025300	3,00 m	25	75,00	160
INOSTOP	0425	3 mm	S	0425025250	2,50 m	25	62,50	160
	0425	3 mm	S	0425025300	3,00 m	25	75,00	160

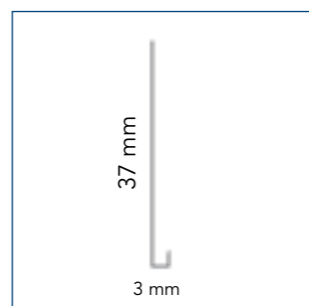
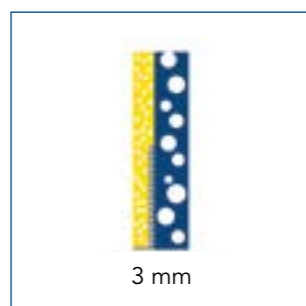

NOM NAAM	EP. D'ENDUIT PLEISTERDIKTE	STOCK STOCK	NR ARTICLE ARTIKEL NR	DIMENSION AFMETING	PIÈCES/EMB. STUKS/VERP.	ML/EMB. LM/VERP.	EMB./PAL. VERP./PAL.	
STOP BEAD PVC	8633	3 mm	S	8633025250	2,50 m	25	62,50	40

## PROFILÉS D'ARRÊT STOP- & AFWERKPROFIELEN

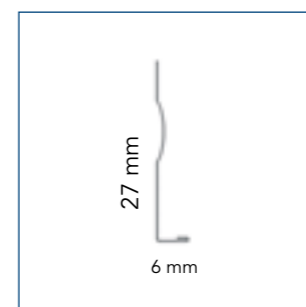
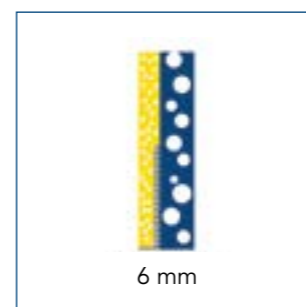

NOM NAAM	EP. D'ENDUIT PLEISTERDIKTE	STOCK STOCK	NR ARTICLE ARTIKEL NR	DIMENSION AFMETING	PIÈCES/EMB. STUKS/VERP.	ML/EMB. LM/VERP.	EMB./PAL. VERP./PAL.	
GALSTOP	0126	6 mm	S	0126025250	2,50 m	25	62,50	160
	0126	6 mm	S	0126025300	3,00 m	25	75,00	160
ALUSTOP	0226	6 mm	S	0226025250	2,50 m	25	62,50	160
	0226	6 mm	S	0226025300	3,00 m	25	75,00	160
INOSTOP	0426	6 mm	S	0426025250	2,50 m	25	62,50	160
	0426	6 mm	S	0426025300	3,00 m	25	75,00	160

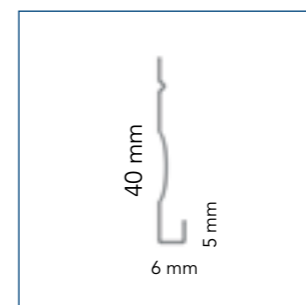
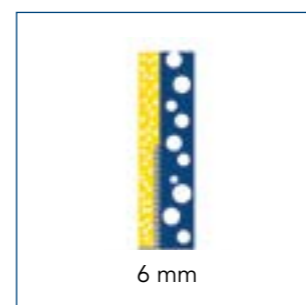

NOM NAAM	EP. D'ENDUIT PLEISTERDIKTE	STOCK STOCK	NR ARTICLE ARTIKEL NR	DIMENSION AFMETING	PIÈCES/EMB. STUKS/VERP.	ML/EMB. LM/VERP.	EMB./PAL. VERP./PAL.	
GALSTOP	0127	6 mm	S	0127020260	2,60 m	20	52,00	160
	0127	6 mm	S	0127020300	3,00 m	20	60,00	160
ALUSTOP	0227	6 mm	S	0227020260	2,60 m	20	52,00	160
	0227	6 mm	S	0227020300	3,00 m	20	60,00	160
INOSTOP	0427	6 mm	S	0427020260	2,60 m	20	52,00	160
	0427	6 mm	S	0427020300	3,00 m	20	60,00	160
GALSTOP COLOR	0627	6 mm		0627020260	2,60 m	20	52,00	160

## PROFILÉS D'ARRÊT STOP- & AFWERKPROFIELEN

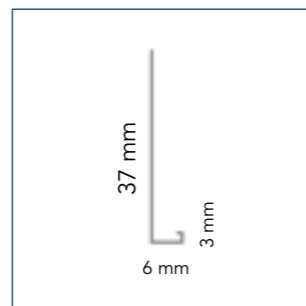
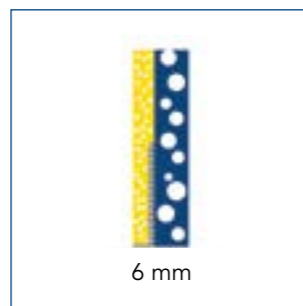

NOM NAAM	EP. D'ENDUIT PLEISTERDIKTE	STOCK STOCK	NR ARTICLE ARTIKEL NR	DIMENSION AFMETING	PIÈCES/EMB. STUKS/VERP.	ML/EMB. LM/VERP.	EMB./PAL. VERP./PAL.
<b>STOP BEAD PVC</b> 8666	6 mm	S	8666025250	2,50 m	25	62,50	40

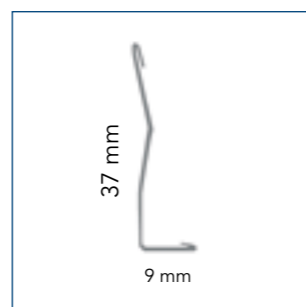
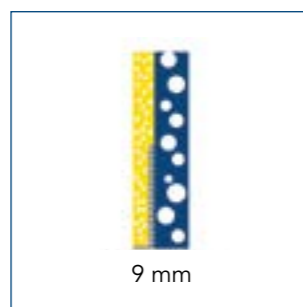

NOM NAAM	EP. D'ENDUIT PLEISTERDIKTE	STOCK STOCK	NR ARTICLE ARTIKEL NR	DIMENSION AFMETING	PIÈCES/EMB. STUKS/VERP.	ML/EMB. LM/VERP.	EMB./PAL. VERP./PAL.
GALSTOP	0122	S	0122025250	2,50 m	25	62,50	160
	0122	S	0122025300	3,00 m	25	75,00	160
ALUSTOP	0222	S	0222050250	2,50 m	50	125,00	80
	0222		0222050275	2,75 m	50	137,50	80
	0222	S	0222050300	3,00 m	50	150,00	80
INOSTOP	0422	S	0422025250	2,50 m	25	62,50	160
	0422	S	0422025300	3,00 m	25	75,00	160

## PROFILÉS D'ARRÊT STOP- & AFWERKPROFIELEN

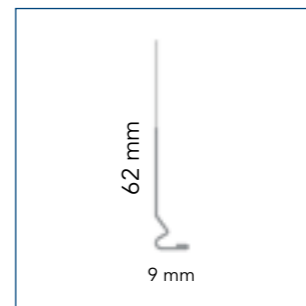
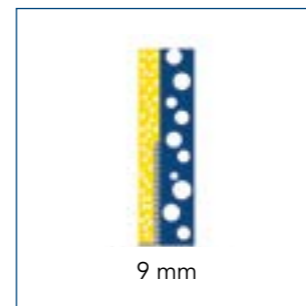

NOM NAAM	EP. D'ENDUIT PLEISTERDIKTE	STOCK STOCK	NR ARTICLE ARTIKEL NR	DIMENSION AFMETING	PIÈCES/EMB. STUKS/VERP.	ML/EMB. LM/VERP.	EMB./PAL. VERP./PAL.
PLASTOP	0023		0023025250	2,50 m	25	62,50	80
	0023		0023025260	2,60 m	25	65,00	80
	0023		0023025300	3,00 m	25	75,00	80
PLASTOP	0123	S	0123025250	2,50 m	25	62,50	80
	0123	S	0123025260	2,60 m	25	65,00	80
	0123	S	0123025275	2,75 m	25	68,75	80
	0123	S	0123025300	3,00 m	25	75,00	80
<b>STOPINOX</b> 0420	9 mm	S	0420025300	3,00 m	25	75,00	80

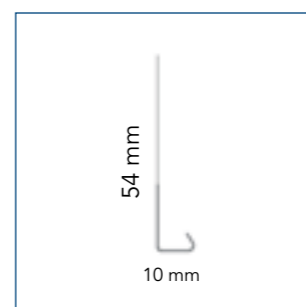
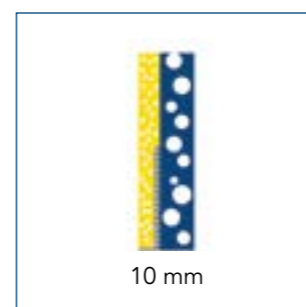

NOM NAAM	EP. D'ENDUIT PLEISTERDIKTE	STOCK STOCK	NR ARTICLE ARTIKEL NR	DIMENSION AFMETING	PIÈCES/EMB. STUKS/VERP.	ML/EMB. LM/VERP.	EMB./PAL. VERP./PAL.
<b>STOPINOX</b> 0423	10 mm		0423025300	3,00 m	25	75,00	80

## PROFILÉS D'ARRÊT STOP- & AFWERKPROFIELEN

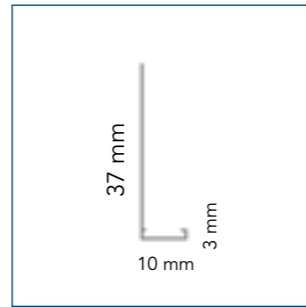
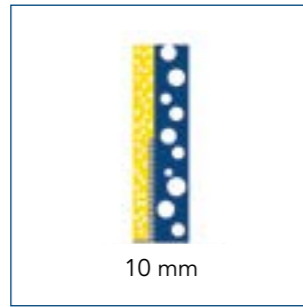

NOM NAAM	EP. D'ENDUIT PLEISTERDIKTE	STOCK STOCK	NR ARTICLE ARTIKEL NR	DIMENSION AFMETING	PIÈCES/EMB. STUKS/VERP.	ML/EMB. LM/VERP.	EMB./PAL. VERP./PAL.
<b>STOP BEAD PVC</b> 8610	10 mm	S	8610025250	2,50 m	25	62,50	40

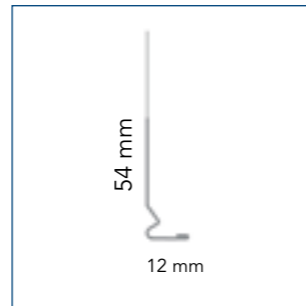
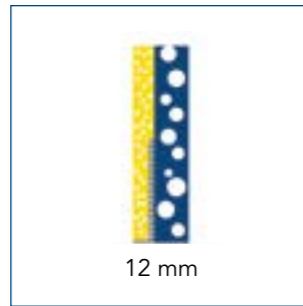

NOM NAAM	EP. D'ENDUIT PLEISTERDIKTE	STOCK STOCK	NR ARTICLE ARTIKEL NR	DIMENSION AFMETING	PIÈCES/EMB. STUKS/VERP.	ML/EMB. LM/VERP.	EMB./PAL. VERP./PAL.
PLASTOP 0124	12 mm	S	0124025300	3,00 m	25	75,00	80
STOP ALU 0224	12 mm	S	0224025300	3,00 m	25	75,00	80
STOPINOX 0421	12 mm	S	0421025300	3,00 m	25	75,00	80

## PROFILÉS D'ARRÊT STOP- & AFWERKPROFIELEN

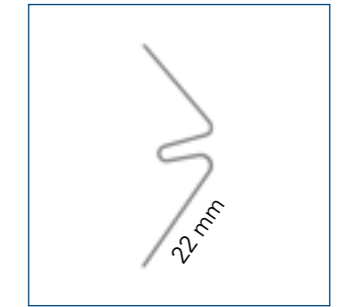
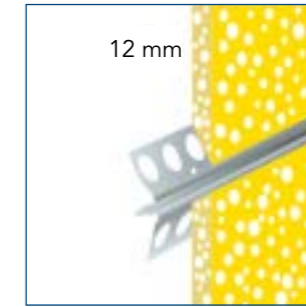

NOM NAAM	EP. D'ENDUIT PLEISTERDIKTE	STOCK STOCK	NR ARTICLE ARTIKEL NR	DIMENSION AFMETING	PIÈCES/EMB. STUKS/VERP.	ML/EMB. LM/VERP.	EMB./PAL. VERP./PAL.
CADERFIX 0155	12 mm		0155025250	2,50 m	25	62,50	120
CADER RACCORD 0156			0156020000		20		
CADER CLIPS 0157			0157025000		25		



## PROFILÉS D'OMBRAGE SCHADUWPROFIELEN

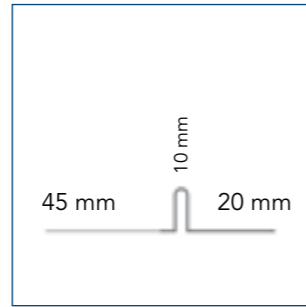
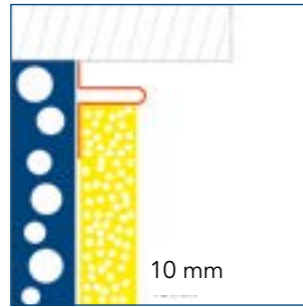

NOM NAAM	EP. D'ENDUIT PLEISTERDIKTE	STOCK STOCK	NR ARTICLE ARTIKEL NR	DIMENSION AFMETING	PIÈCES/EMB. STUKS/VERP.	ML/EMB. LM/VERP.	EMB./PAL. VERP./PAL.
CADERSTOP L 0152	10 mm		0152025300	3,00 m	25	75,00	100

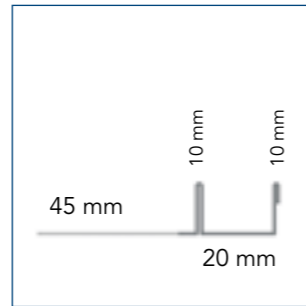
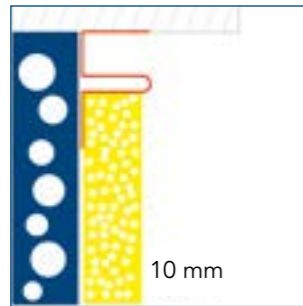

NOM NAAM	EP. D'ENDUIT PLEISTERDIKTE	STOCK STOCK	NR ARTICLE ARTIKEL NR	DIMENSION AFMETING	PIÈCES/EMB. STUKS/VERP.	ML/EMB. LM/VERP.	EMB./PAL. VERP./PAL.
CADERSTOP U 0153	10 mm		0153025300	3,00 m	25	75,00	100

## PROFILÉS D'ÉPAISSEUR AFSTRIJKPROFIELEN

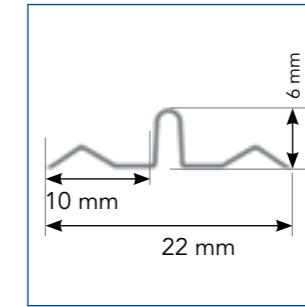
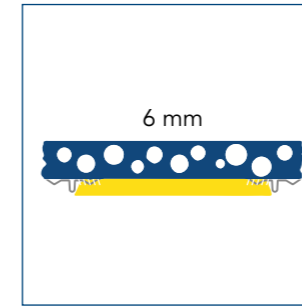

NOM NAAM	EP. D'ENDUIT PLEISTERDIKTE	STOCK STOCK	NR ARTICLE ARTIKEL NR	DIMENSION AFMETING	PIÈCES/EMB. STUKS/VERP.	ML/EMB. LM/VERP.	EMB./PAL. VERP./PAL.	
REGLE	0140	6 mm	S	0140050250	2,50 m	50	125,00	125
	0140	6 mm	S	0140050260	2,60 m	50	130,00	125
	0140	6 mm	S	0140050270	2,70 m	50	135,00	125
	0140	6 mm		0140050280	2,80 m	50	140,00	125
	0140	6 mm	S	0140050300	3,00 m	50	150,00	125
REGLALU	0240	6 mm	S	0240050250	2,50 m	50	125,00	125
REGLINOX	0440	6 mm	S	0440050250	2,50 m	50	125,00	125

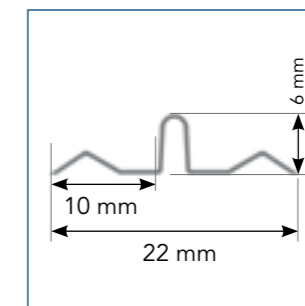
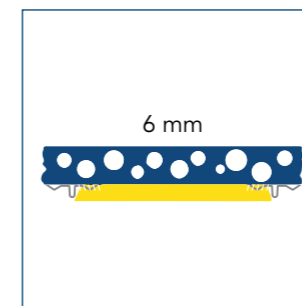

NOM NAAM	EP. D'ENDUIT PLEISTERDIKTE	STOCK STOCK	NR ARTICLE ARTIKEL NR	DIMENSION AFMETING	PIÈCES/EMB. STUKS/VERP.	ML/EMB. LM/VERP.	EMB./PAL. VERP./PAL.	
REGLE ECO	0144	6 mm	S	0144050250	2,50 m	50	125,00	125
	0144	6 mm	S	0144050260	2,60 m	50	130,00	125
	0144	6 mm	S	0144050300	3,00 m	50	150,00	125

## PROFILÉS D'ÉPAISSEUR AFSTRIJKPROFIELEN

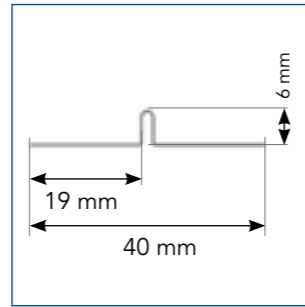
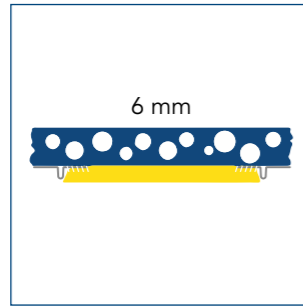

NOM NAAM	EP. D'ENDUIT PLEISTERDIKTE	STOCK STOCK	NR ARTICLE ARTIKEL NR	DIMENSION AFMETING	PIÈCES/EMB. STUKS/VERP.	ML/EMB. LM/VERP.	EMB./PAL. VERP./PAL.
<b>REGLE PVC</b>	<b>8031</b>	6 mm	8031050300	3,00 m	50	150,00	100

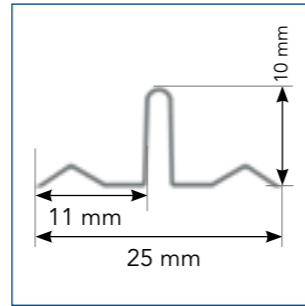
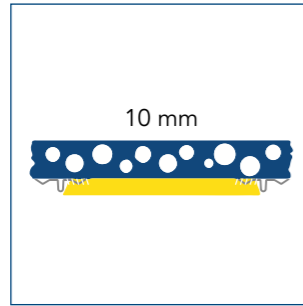



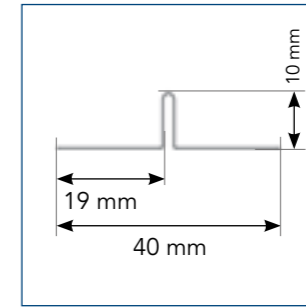
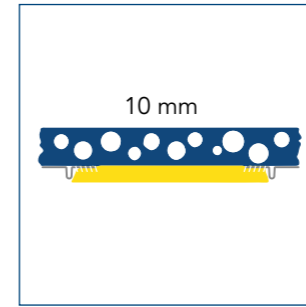

NOM NAAM	EP. D'ENDUIT PLEISTERDIKTE	STOCK STOCK	NR ARTICLE ARTIKEL NR	DIMENSION AFMETING	PIÈCES/EMB. STUKS/VERP.	ML/EMB. LM/VERP.	EMB./PAL. VERP./PAL.	
REGLE	0141	10 mm	S	0141050250	2,50 m	50	125,00	100
	0141	10 mm	S	0141050260	2,60 m	50	130,00	100
REGLALU	0241	10 mm		0241050250	2,50 m	50	125,00	125
	0241	10 mm	S	0241050260	2,60 m	50	130,00	125
	0241	10 mm		0241050300	3,00 m	50	150,00	125
REGLINOX	0441	10 mm	S	0441050250	2,50 m	50	125,00	125

## PROFILÉS D'ÉPAISSEUR AFSTRIJKPROFIELEN



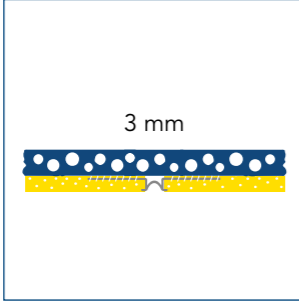
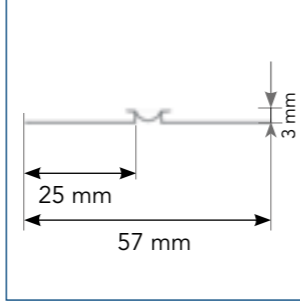

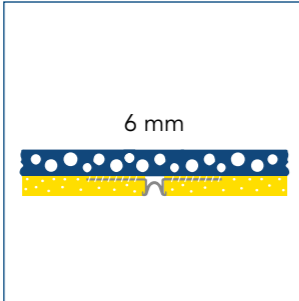
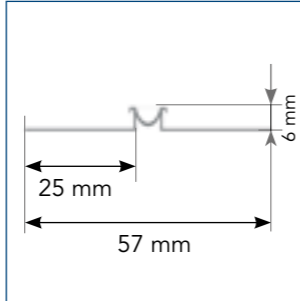

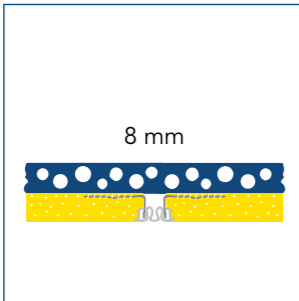
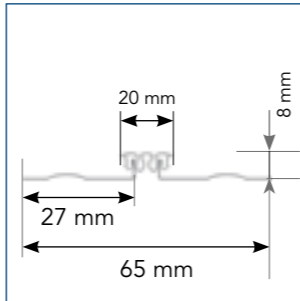
NOM NAAM	EP. D'ENDUIT PLEISTERDIKTE	STOCK STOCK	NR ARTICLE ARTIKEL NR	DIMENSION AFMETING	PIÈCES/EMB. STUKS/VERP.	ML/EMB. LM/VERP.	EMB./PAL. VERP./PAL.
<b>REGLE PVC</b>	<b>8032</b>	10 mm	8032050300	3,00 m	50	150,00	100

## PROFILÉS DE DILATATION UITZETTINGSPROFIELEN

							
NOM NAAM	EP. D'ENDUIT PLEISTERDIKTE	STOCK STOCK	NR ARTICLE ARTIKEL NR	DIMENSION AFMETING	PIÈCES/EMB. STUKS/VERP.	ML/EMB. LM/VERP.	EMB./PAL. VERP./PAL.
<b>DILAT PVC</b>	<b>8503</b>	3 mm		2,50 m	25	62,50	40
							
NOM NAAM	EP. D'ENDUIT PLEISTERDIKTE	STOCK STOCK	NR ARTICLE ARTIKEL NR	DIMENSION AFMETING	PIÈCES/EMB. STUKS/VERP.	ML/EMB. LM/VERP.	EMB./PAL. VERP./PAL.
<b>DILAT PVC</b>	<b>8506</b>	6 mm		2,50 m	25	62,50	40
							
NOM NAAM	EP. D'ENDUIT PLEISTERDIKTE	STOCK STOCK	NR ARTICLE ARTIKEL NR	DIMENSION AFMETING	PIÈCES/EMB. STUKS/VERP.	ML/EMB. LM/VERP.	EMB./PAL. VERP./PAL.
<b>DILATINOX</b>	<b>2404</b>	8 mm	S	3,00 m	5	15,00	54

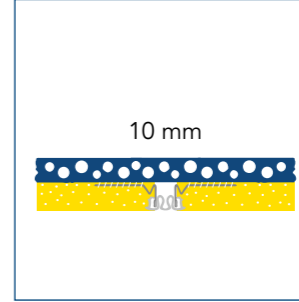
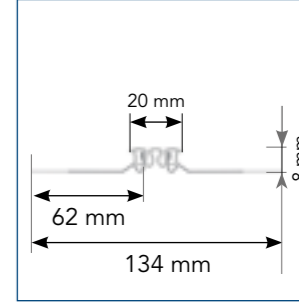
## PROFILÉS DE DILATATION UITZETTINGSPROFIELEN

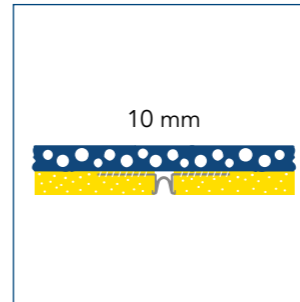
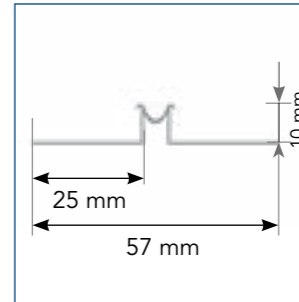
							
NOM NAAM	EP. D'ENDUIT PLEISTERDIKTE	STOCK STOCK	NR ARTICLE ARTIKEL NR	DIMENSION AFMETING	PIÈCES/EMB. STUKS/VERP.	ML/EMB. LM/VERP.	EMB./PAL. VERP./PAL.
<b>DILATGAL</b>	<b>2001</b>	S		3,00 m	10	30,00	54
<b>DILATINOX</b>	<b>2401</b>			3,00 m	10	30,00	54
							
NOM NAAM	EP. D'ENDUIT PLEISTERDIKTE	STOCK STOCK	NR ARTICLE ARTIKEL NR	DIMENSION AFMETING	PIÈCES/EMB. STUKS/VERP.	ML/EMB. LM/VERP.	EMB./PAL. VERP./PAL.
<b>DILAT PVC</b>	<b>8510</b>	S		2,50 m	25	62,50	40

## PROFILÉS PVC POUR PORTES & FENÊTRES PVC AFWERKPROFIELEN VOOR DEUREN & RAMEN

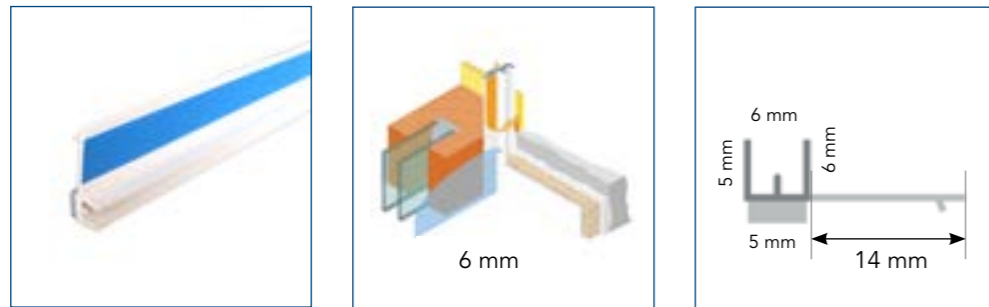

NOM NAAM	EP. D'ENDUIT PLEISTERDIKTE	STOCK STOCK	NR ARTICLE ARTIKEL NR	DIMENSION AFMETING	PIÈCES/EMB. STUKS/VERP.	ML/EMB. LM/VERP.	EMB./PAL. VERP./PAL.
PROFI INTER PRO	8166	6 mm		1,40 m	30	42,00	90
	8166	6 mm	S	2,40 m	30	72,00	90
	8166	6 mm		3,00 m	30	90,00	90

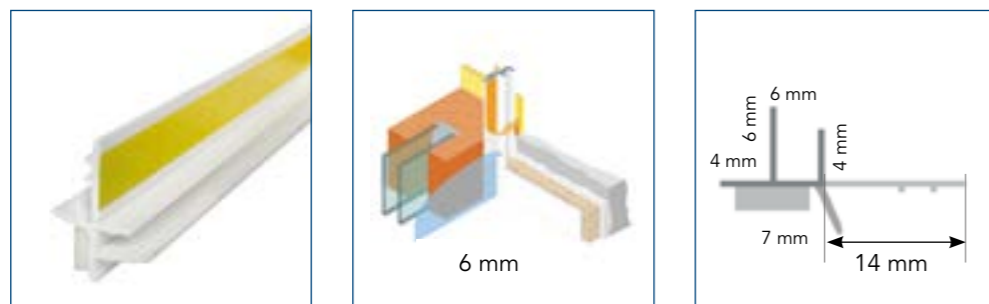

NOM NAAM	EP. D'ENDUIT PLEISTERDIKTE	STOCK STOCK	NR ARTICLE ARTIKEL NR	DIMENSION AFMETING	PIÈCES/EMB. STUKS/VERP.	ML/EMB. LM/VERP.	EMB./PAL. VERP./PAL.
PROFI INTER ECO LIPPE	8866	6 mm		2,40 m	25	60,00	50

## PROFILÉS PVC POUR PORTES & FENÊTRES PVC AFWERKPROFIELEN VOOR DEUREN & RAMEN

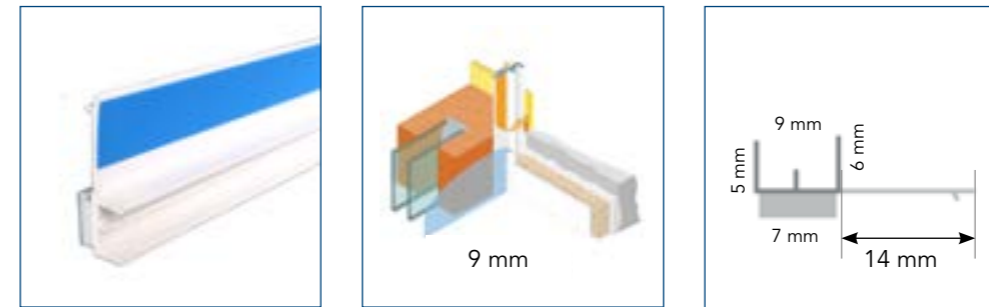

NOM NAAM	EP. D'ENDUIT PLEISTERDIKTE	STOCK STOCK	NR ARTICLE ARTIKEL NR	DIMENSION AFMETING	PIÈCES/EMB. STUKS/VERP.	ML/EMB. LM/VERP.	EMB./PAL. VERP./PAL.
PROFI MINI PRO	8108	9 mm		1,40 m	30	42,00	90
	8108	9 mm	S	2,40 m	30	72,00	90
	8108	9 mm		3,00 m	30	90,00	90

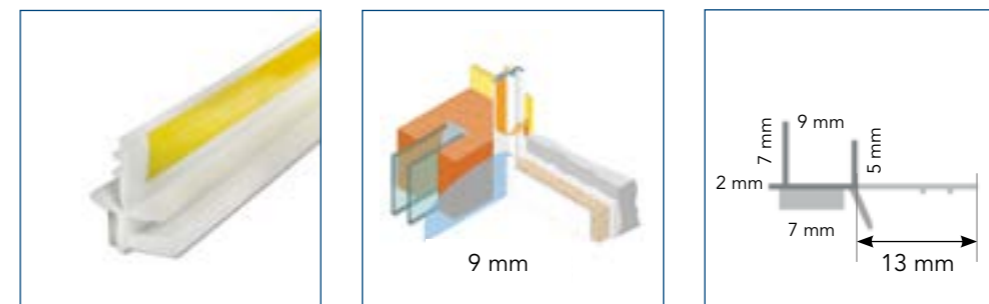

NOM NAAM	EP. D'ENDUIT PLEISTERDIKTE	STOCK STOCK	NR ARTICLE ARTIKEL NR	DIMENSION AFMETING	PIÈCES/EMB. STUKS/VERP.	ML/EMB. LM/VERP.	EMB./PAL. VERP./PAL.
PROFI MINI LIPPE	8888	9 mm		2,40 m	25	60,00	48

## PROFILÉS PVC POUR PORTES & FENÊTRES PVC AFWERKPROFIELEN VOOR DEUREN & RAMEN

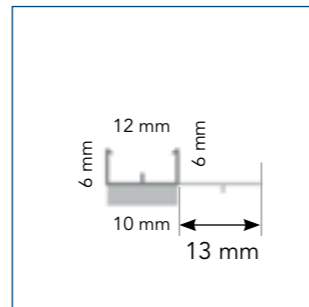
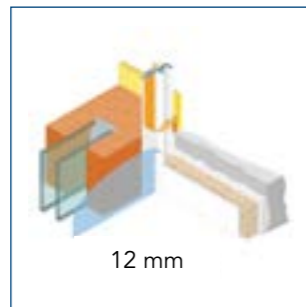

NOM NAAM	EP. D'ENDUIT PLEISTERDIKTE	STOCK STOCK	NR ARTICLE ARTIKEL NR	DIMENSION AFMETING	PIÈCES/EMB. STUKS/VERP.	ML/EMB. LM/VERP.	EMB./PAL. VERP./PAL.
APU A13 / MIDI	8112	12 mm	8112030140	1,40 m	30	42,00	100
	8112	12 mm	8112030240	2,40 m	30	72,00	100

Demandez-nous le catalogue complet  
**APU**

Vraag onze **APU** catalogus

www.apu.ch



## SUPPORTS POUR ENDUITS PLEISTERDRAGERS

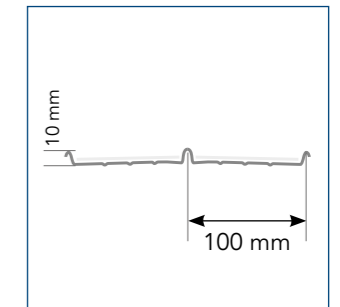
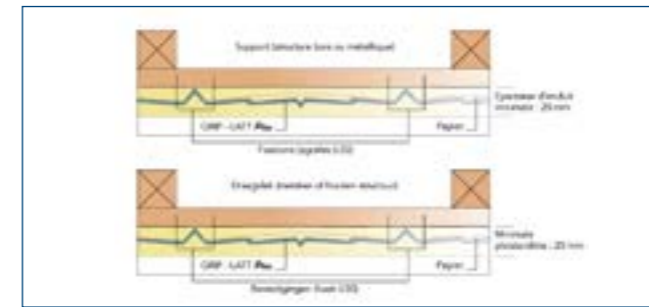

NOM NAAM	EP. D'ENDUIT PLEISTERDIKTE	STOCK STOCK	NR ARTICLE ARTIKEL NR	DIMENSION AFMETING	PIÈCES/EMB. STUKS/VERP.	ML/EMB. LM/VERP.	EMB./PAL. VERP./PAL.	
GRIP-LATT PLUS	6000	20 mm	S	6000015250	0,60 X 2,50 m	15	22,50 m <sup>2</sup>	30

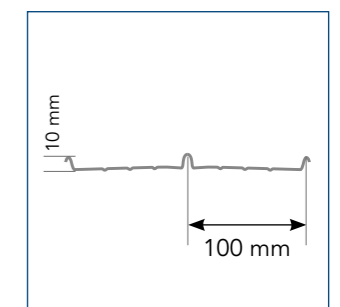
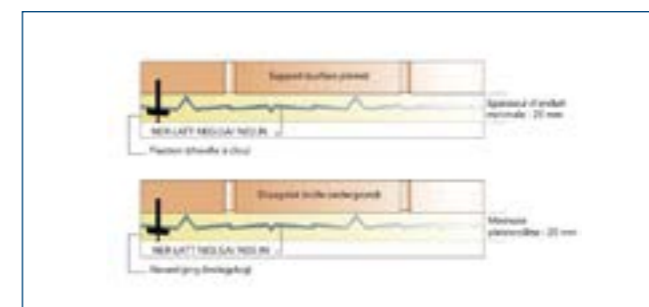
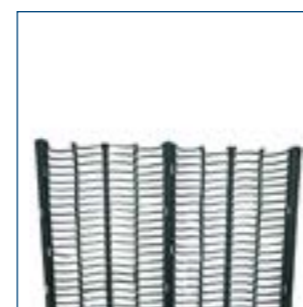

NOM NAAM	EP. D'ENDUIT PLEISTERDIKTE	STOCK STOCK	NR ARTICLE ARTIKEL NR	DIMENSION AFMETING	PIÈCES/EMB. STUKS/VERP.	ML/EMB. LM/VERP.	EMB./PAL. VERP./PAL.	
NER-LATT	6100	20 mm	S	6100015250	0,60 X 2,50 m	15	22,50 m <sup>2</sup>	50
NER-LATT INOX	6400	20 mm	S	6400010250	0,60 X 2,50 m	10	15 m <sup>2</sup>	50

## FIBRE DE VERRE GLASVEZEL

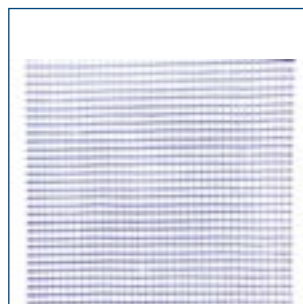

NOM NAAM	STOCK STOCK	N° ARTICLE ARTIKEL NR	DIMENSION AFMETING	PCES/EMB. STUKS/VERP.	ML/EMB. LM/VERP.	EMB./PAL. VERP./PAL.
ARMATEX 4x4 (100 gr/m <sup>2</sup> ) - certifié CE gecertificeerd (blanc/wit)	4040	4040001012	100 m X 12,5 cm	8		24
	4041	4041001025	100 m X 25 cm	4		24
	4042	4042001050	100 m X 50 cm	2		24
	4043	4043001100	100 m X 100 cm	1		24

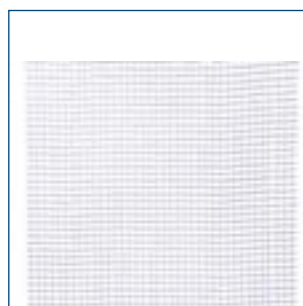

NOM NAAM	STOCK STOCK	N° ARTICLE ARTIKEL NR	DIMENSION AFMETING	PCES/EMB. STUKS/VERP.	ML/EMB. LM/VERP.	EMB./PAL. VERP./PAL.
ARMATEX 4x4 (75 gr/m <sup>2</sup> ) - certifié CE gecertificeerd - (blanc/wit)	4044	4044001012	100 m X 12,5 cm	8		24
	4045	4045001025	100 m X 25 cm	4		24
	4046	4046001050	100 m X 50 cm	2		24
	4047	4047001100	100 m X 100 cm	1		24

## FIBRE DE VERRE GLASVEZEL



NOM NAAM	STOCK STOCK	N° ARTICLE ARTIKEL NR	DIMENSION AFMETING	PCES/EMB. STUKS/VERP.	ML/EMB. LM/VERP.	EMB./PAL. VERP./PAL.
CHAPNET VERTEX (bleu/blauw)	4905	4905001050	50 m X 1 m	1	50 m <sup>2</sup>	15
	4910	4910001100	100 m X 1 m	1	100 m <sup>2</sup>	9

## ACCESSOIRES TOEBEHOREN



NOM NAAM	STOCK STOCK	NR ARTICLE ARTIKEL NR	DIMENSION AFMETING	PIÈCES/EMB. STUKS/VERP.	EMB./PAL. VERP./PAL.
POUTRECLIPS	1013	1013100000		100	



NOM NAAM	STOCK STOCK	NR ARTICLE ARTIKEL NR	DIMENSION AFMETING	PIÈCES/EMB. STUKS/VERP.	EMB./PAL. VERP./PAL.
STUCLOPER ECO	1012	1012120065	65 m <sup>2</sup> (+/- 1,20 X 54,17 m)	1	41



NOM NAAM	STOCK STOCK	NR ARTICLE ARTIKEL NR	DIMENSION AFMETING	PIÈCES/EMB. STUKS/VERP.	EMB./PAL. VERP./PAL.
STUCLOPER	1016	1016100050	50 m <sup>2</sup> (+/- 0,9 X 55,55 m)	1	28
	1017	1017130050	50 m <sup>2</sup> (+/- 1,2 X 41,66 m)	1	28

## ACCESSOIRES TOEBEHOREN

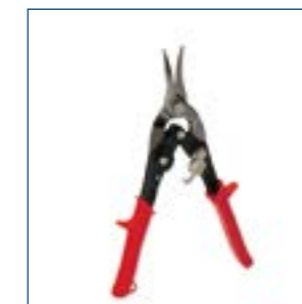
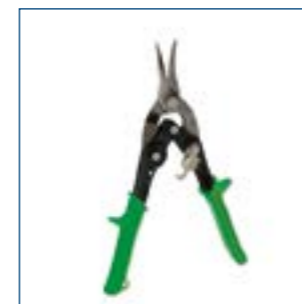
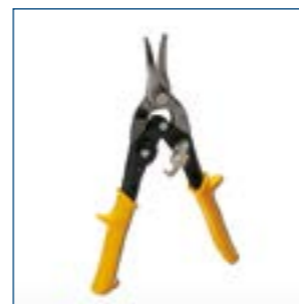

NOM NAAM	STOCK STOCK	NR ARTICLE ARTIKEL NR	DIMENSION AFMETING	PIÈCES/EMB. STUKS/VERP.	EMB./PAL. VERP./PAL.
PINCE POUR PROFILÉS / PROFIEL SCHAAR	1200	1200006000		6	
PINCE POUR PROFILÉS (vert - droitier) / PROFIEL SCHAAR (groen - rechtshandig)	1201	1201005000		5	
PINCE POUR PROFILÉS (rouge - gaucher) / PROFIEL SCHAAR (rood - linkshandig)	1202	1202005000		5	



NOM NAAM	STOCK STOCK	NR ARTICLE ARTIKEL NR	DIMENSION AFMETING	PIÈCES/EMB. STUKS/VERP.	EMB./PAL. VERP./PAL.
PINCE MULTI COUP / MULTI COUP SCHAAR	1205	1205001000		1	

## ACCESSOIRES TOEBEHOREN



NOM NAAM	STOCK STOCK	NR ARTICLE ARTIKEL NR	DIMENSION AFMETING	PIÈCES/EMB. STUKS/VERP.	EMB./PAL. VERP./PAL.
PINCE A SERTIR / VERBINDINGS- TANG LATT-FIX	1206	S	1206001000	1	



NOM NAAM	STOCK STOCK	NR ARTICLE ARTIKEL NR	DIMENSION AFMETING	PIÈCES/EMB. STUKS/VERP.	EMB./PAL. VERP./PAL.
PINCE PVC / PVC SCHAAR APU Z12	1210		1210001000	1	

## ENDUITS EXTÉRIEURS BUITENBEPLEISTERING



ENDUITS EXTÉRIEURS • BUITENBEPLEISTERING



## PROFILÉS D'ANGLE HOEKPROFIELEN

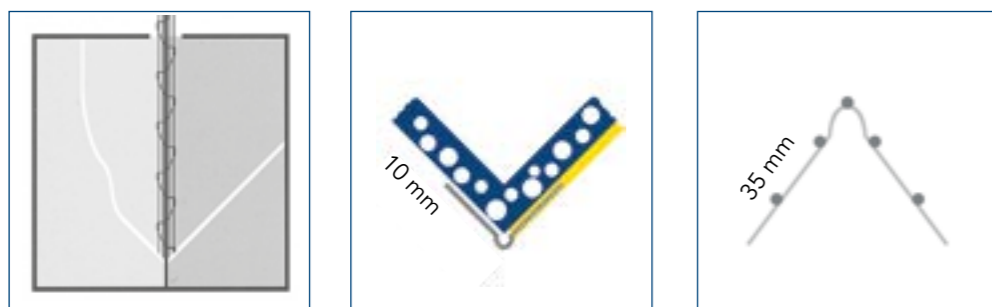

NOM NAAM		EP. D'ENDUIT PLEISTERDIKTE	STOCK STOCK	NR ARTICLE ARTIKEL NR	DIMENSION AFMETING	PIÈCES/EMB. STUKS/VERP.	ML/EMB. LM/VERP.	EMB./PAL. VERP./PAL.
WIDRA IP	0182	10 mm		0182040295	2,95 m	40	118,00	48
WIDRA IPE	0429	10 mm		0429040295	2,95 m	40	118,00	24

## PROFILÉS D'ANGLE HOEKPROFIELEN



NOM NAAM		EP. D'ENDUIT PLEISTERDIKTE	STOCK STOCK	NR ARTICLE ARTIKEL NR	DIMENSION AFMETING	PIÈCES/EMB. STUKS/VERP.	ML/EMB. LM/VERP.	EMB./PAL. VERP./PAL.
CORNER ALU	0214	10 mm	S	0214025300	3,00 m	25	75,00	80
CORNER ALU COLOR (blanc cassé/ gebroken wit) *	9914	10 mm	S	9914001300	3,00 m	10	30,00	40
CORNER ALU COLOR (beige clair/ licht beige) *	9914	10 mm	S	9914002300	3,00 m	10	30,00	40
CORNER ALU COLOR (beige sable/ zand beige) *	9914	10 mm		9914003300	3,00 m	10	30,00	40
CORNER ALU COLOR (beige ocre/ oker beige) *	9914	10 mm		9914004300	3,00 m	10	30,00	40
CORNER ALU COLOR (beige saumon/zalm beige) *	9914	10 mm		9914005300	3,00 m	10	30,00	40
CORNER ALU COLOR (gris beige/ beige grijs) *	9914	10 mm		9914006300	3,00 m	10	30,00	40
CORNER ALU COLOR (bleu clair/ licht blauw) *	9914	10 mm		9914007300	3,00 m	10	30,00	40
CORNER ALU COLOR (rose clair/ licht rose) *	9914	10 mm		9914008300	3,00 m	10	30,00	40
CORNER ALU COLOR (gris ciment/ cement grijs) *	9914	10 mm		9914009300	3,00 m	10	30,00	40
CORNER ALU COLOR (rouge corail/ koraal rood) *	9914	10 mm		9914010300	3,00 m	10	30,00	40

\* Commande min. 1 pal. / Min. bestelling 1 pal.

## PROFILÉS D'ANGLE HOEKPROFIELEN

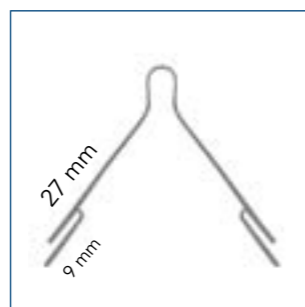
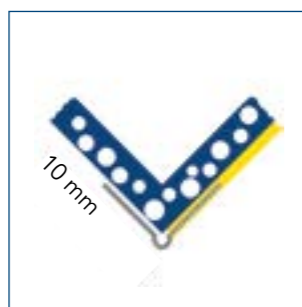

NOM NAAM	EP. D'ENDUIT PLEISTERDIKTE	STOCK STOCK	NR ARTICLE ARTIKEL NR	DIMENSION AFMETING	PIÈCES/EMB. STUKS/VERP.	ML/EMB. LM/VERP.	EMB./PAL. VERP./PAL.	
CORNER INOX	0413	10 mm	S	0413015250	2,50 m	15	37,50	100
	0413	10 mm	S	0413015300	3,00 m	15	45,00	100

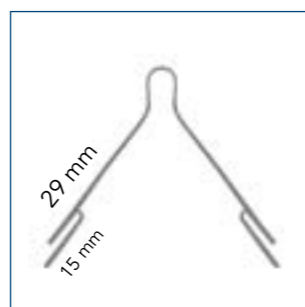
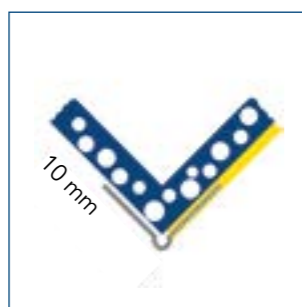

NOM NAAM	EP. D'ENDUIT PLEISTERDIKTE	STOCK STOCK	NR ARTICLE ARTIKEL NR	DIMENSION AFMETING	PIÈCES/EMB. STUKS/VERP.	ML/EMB. LM/VERP.	EMB./PAL. VERP./PAL.	
CORNER INOX	0415	10 mm	S	0415015250	2,50 m	15	37,50	100
	0415	10 mm	S	0415015300	3,00 m	15	45,00	100

## PROFILÉS D'ANGLE HOEKPROFIELEN

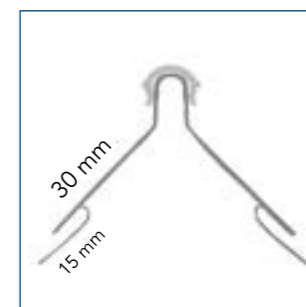
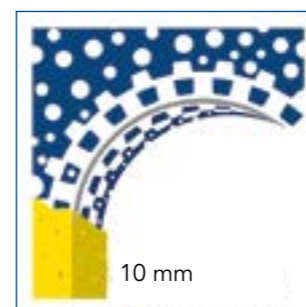

NOM NAAM	EP. D'ENDUIT PLEISTERDIKTE	STOCK STOCK	NR ARTICLE ARTIKEL NR	DIMENSION AFMETING	PIÈCES/EMB. STUKS/VERP.	ML/EMB. LM/VERP.	EMB./PAL. VERP./PAL.	
CORNER RONDO PVC	2110	10 mm		2110010300	3,00 m	10	30,00	80
CORNER RONDO PVC COLOR (beige)	9110	10 mm		9110010300	3,00 m	10	30,00	80

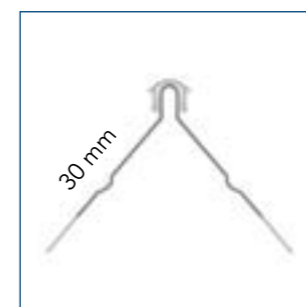
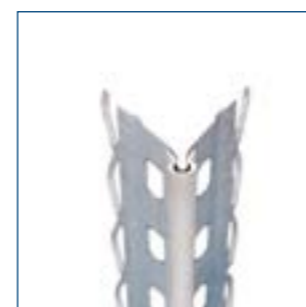

NOM NAAM	EP. D'ENDUIT PLEISTERDIKTE	STOCK STOCK	NR ARTICLE ARTIKEL NR	DIMENSION AFMETING	PIÈCES/EMB. STUKS/VERP.	ML/EMB. LM/VERP.	EMB./PAL. VERP./PAL.	
PERFOR PVC	2112	10 mm	S	2112015300	3,00 m	15	45,00	120

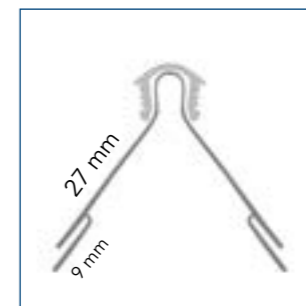
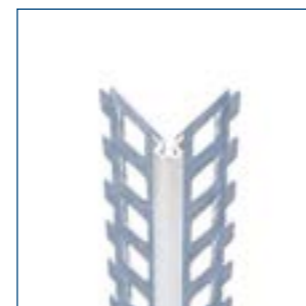

NOM NAAM	EP. D'ENDUIT PLEISTERDIKTE	STOCK STOCK	NR ARTICLE ARTIKEL NR	DIMENSION AFMETING	PIÈCES/EMB. STUKS/VERP.	ML/EMB. LM/VERP.	EMB./PAL. VERP./PAL.	
CORNER PVC	2113	10 mm	S	2113015300	3,00 m	15	45,00	120

## PROFILÉS D'ANGLE HOEKPROFIELEN



NOM NAAM		EP. D'ENDUIT PLEISTERDIKTE	STOCK STOCK	NR ARTICLE ARTIKEL NR	DIMENSION AFMETING	PIÈCES/EMB. STUKS/VERP.	ML/EMB. LM/VERP.	EMB./PAL. VERP./PAL.
CORNER PVC	2115	10 mm	S	2115015300	3,00 m	15	45,00	120
CORNER PVC COLOR (gris/grijs)	9115	10 mm		9115009300	3,00 m	15	45,00	120
CORNER PVC COLOR (beige)	9115	10 mm		9115003300	3,00 m	15	45,00	120



NOM NAAM		EP. D'ENDUIT PLEISTERDIKTE	STOCK STOCK	NR ARTICLE ARTIKEL NR	DIMENSION AFMETING	PIÈCES/EMB. STUKS/VERP.	ML/EMB. LM/VERP.	EMB./PAL. VERP./PAL.
CORNER BEAD PVC	8010	10 mm	S	8010025250	2,50 m	25	62,50	40
CORNER BEAD PVC (gris/grijs)	9010	10 mm	S	9010025250	2,50 m	25	62,50	40
CORNER BEAD PVC (beige)	9012	10 mm		9012025250	2,50 m	25	62,50	40

## PROFILÉS D'ANGLE HOEKPROFIELEN

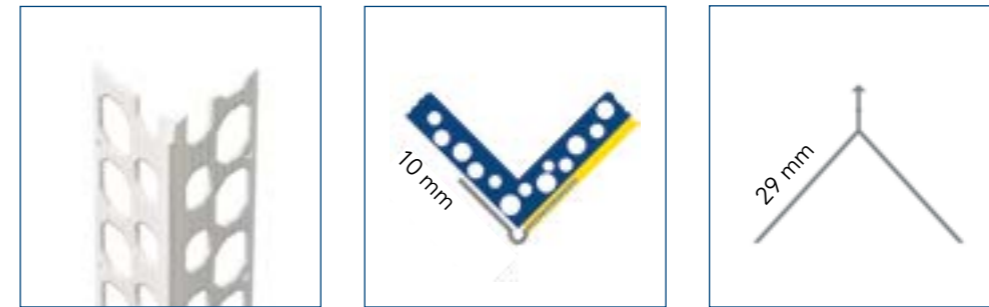

NOM NAAM		EP. D'ENDUIT PLEISTERDIKTE	STOCK STOCK	NR ARTICLE ARTIKEL NR	DIMENSION AFMETING	PIÈCES/EMB. STUKS/VERP.	ML/EMB. LM/VERP.	EMB./PAL. VERP./PAL.
CORNER BEAD PVC	8011	10 mm	S	8011025250	2,50 m	25	62,50	40
CORNER BEAD PVC (gris/grijs)	9011	10 mm		9011025250	2,50 m	25	62,50	40
CORNER BEAD PVC (beige)	9013	10 mm		9013025250	2,50 m	25	62,50	40

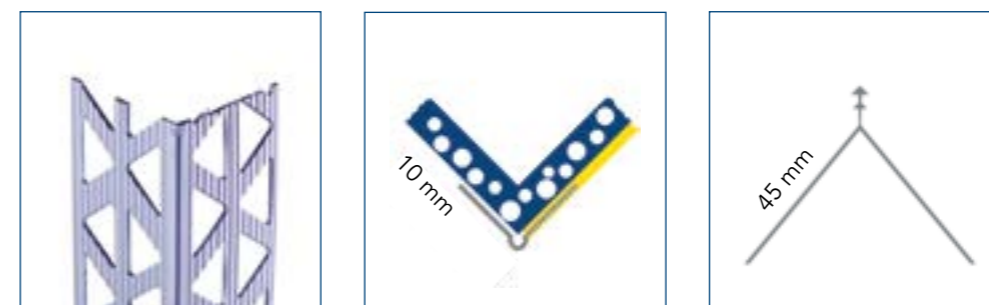

NOM NAAM		EP. D'ENDUIT PLEISTERDIKTE	STOCK STOCK	NR ARTICLE ARTIKEL NR	DIMENSION AFMETING	PIÈCES/EMB. STUKS/VERP.	ML/EMB. LM/VERP.	EMB./PAL. VERP./PAL.
CORNER BEAD PVC ECO	8410	10 mm		8410025270	2,70 m	25	67,50	40



NOM NAAM		EP. D'ENDUIT PLEISTERDIKTE	STOCK STOCK	NR ARTICLE ARTIKEL NR	DIMENSION AFMETING	PIÈCES/EMB. STUKS/VERP.	ML/EMB. LM/VERP.	EMB./PAL. VERP./PAL.
SUPLEX INOX	0418	15 mm	S	0418015300	3,00 m	15	45,00	100

## PROFILÉS D'ANGLE HOEKPROFIELEN

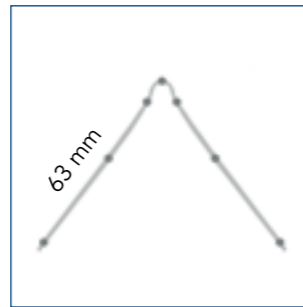
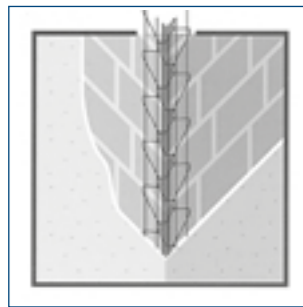

NOM NAAM	EP. D'ENDUIT PLEISTERDIKTE	STOCK STOCK	NR ARTICLE ARTIKEL NR	DIMENSION AFMETING	PIÈCES/EMB. STUKS/VERP.	ML/EMB. LM/VERP.	EMB./PAL. VERP./PAL.	
WIDRA AP	0174	15 mm	S	0174040295	2,95 m	40	118,00	48
WIDRA APS	0181	15 mm	S	0181040295	2,95 m	40	118,00	40
WIDRA APE	0428	15 mm		0428040295	2,95 m	40	118,00	20
WIDRA APP COLOR (blanc/wit)	9174	15 mm		9174040295	2,95 m	40	118,00	40

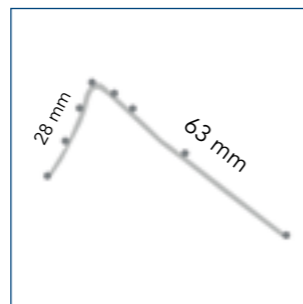
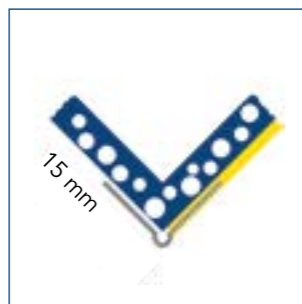
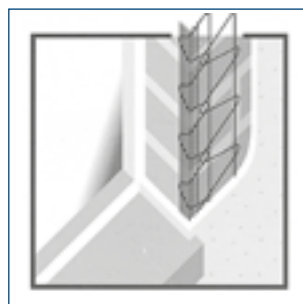

NOM NAAM	EP. D'ENDUIT PLEISTERDIKTE	STOCK STOCK	NR ARTICLE ARTIKEL NR	DIMENSION AFMETING	PIÈCES/EMB. STUKS/VERP.	ML/EMB. LM/VERP.	EMB./PAL. VERP./PAL.	
WIDRA APA	0175	15 mm		0175040295	2,95 m	40	118,00	40

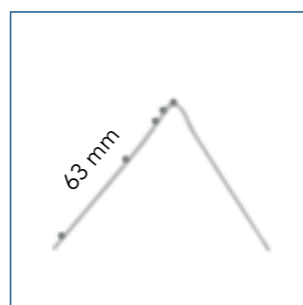
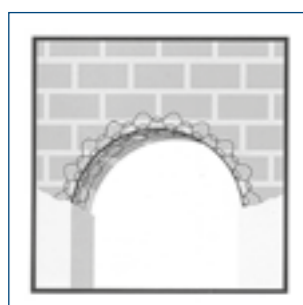

NOM NAAM	EP. D'ENDUIT PLEISTERDIKTE	STOCK STOCK	NR ARTICLE ARTIKEL NR	DIMENSION AFMETING	PIÈCES/EMB. STUKS/VERP.	ML/EMB. LM/VERP.	EMB./PAL. VERP./PAL.	
WIDRA APB	0176	15 mm		0176040295	2,95 m	40	118,00	20

## PROFILÉS D'ANGLE HOEKPROFIELEN

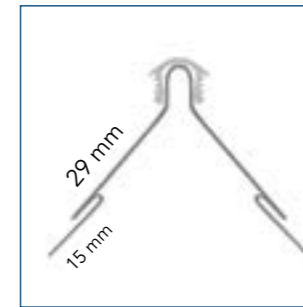

NOM NAAM	EP. D'ENDUIT PLEISTERDIKTE	STOCK STOCK	NR ARTICLE ARTIKEL NR	DIMENSION AFMETING	PIÈCES/EMB. STUKS/VERP.	ML/EMB. LM/VERP.	EMB./PAL. VERP./PAL.	
CORNER PVC	2114	15 mm	S	2114015300	3,00 m	15	45,00	120

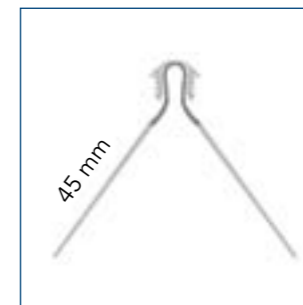
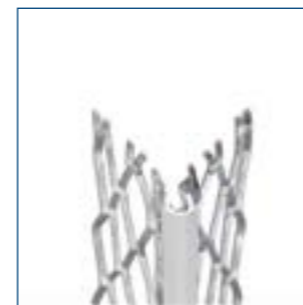

NOM NAAM	EP. D'ENDUIT PLEISTERDIKTE	STOCK STOCK	NR ARTICLE ARTIKEL NR	DIMENSION AFMETING	PIÈCES/EMB. STUKS/VERP.	ML/EMB. LM/VERP.	EMB./PAL. VERP./PAL.	
SUPLEX PVC	2118	15 mm	S	2118015300	3,00 m	15	45,00	80

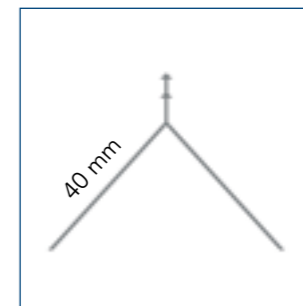

NOM NAAM	EP. D'ENDUIT PLEISTERDIKTE	STOCK STOCK	NR ARTICLE ARTIKEL NR	DIMENSION AFMETING	PIÈCES/EMB. STUKS/VERP.	ML/EMB. LM/VERP.	EMB./PAL. VERP./PAL.	
CORNER BEAD PVC	8015	15 mm	S	8015025250	2,50 m	25	62,50	40
CORNER BEAD PVC (gris/grijs)	9015	15 mm		9015025250	2,50 m	25	62,50	40
CORNER BEAD PVC (beige)	9016	15 mm		9016025250	2,50 m	25	62,50	40

## PROFILÉS D'ANGLE HOEKPROFIELEN

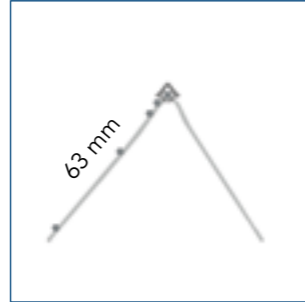
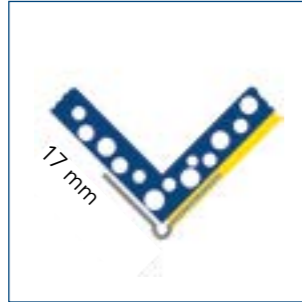
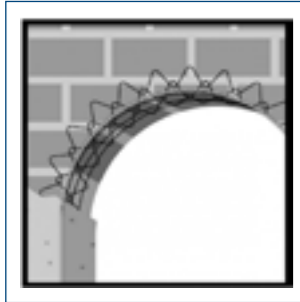

NOM NAAM	EP. D'ENDUIT PLEISTERDIKTE	STOCK STOCK	NR ARTICLE ARTIKEL NR	DIMENSION AFMETING	PIÈCES/EMB. STUKS/VERP.	ML/EMB. LM/VERP.	EMB./PAL. VERP/PAL.	
WIDRA APBK	0177	17 mm	S	0177025295	2,95 m	25	73,75	30

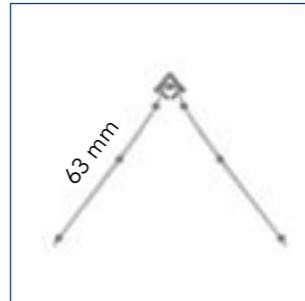
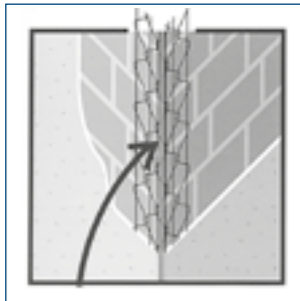

NOM NAAM	EP. D'ENDUIT PLEISTERDIKTE	STOCK STOCK	NR ARTICLE ARTIKEL NR	DIMENSION AFMETING	PIÈCES/EMB. STUKS/VERP.	ML/EMB. LM/VERP.	EMB./PAL. VERP/PAL.	
WIDRA APK	0180	17 mm	S	0180025295	2,95 m	25	73,75	30

## PROFILÉS D'ARRÊT STOP- & AFWERKPROFIELEN

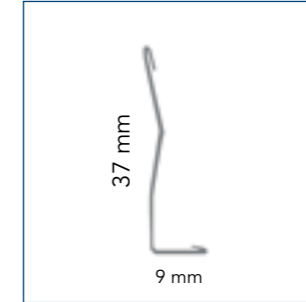
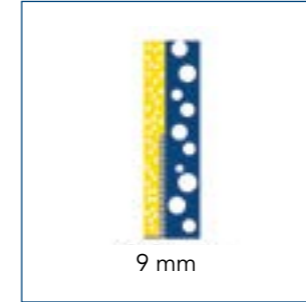

NOM NAAM	EP. D'ENDUIT PLEISTERDIKTE	STOCK STOCK	NR ARTICLE ARTIKEL NR	DIMENSION AFMETING	PIÈCES/EMB. STUKS/VERP.	ML/EMB. LM/VERP.	EMB./PAL. VERP/PAL.	
ALUSTOP	0222	9 mm	S	0222050250	2,50 m	50	125,00	80
	0222	9 mm		0222050275	2,75 m	50	137,50	80
	0222	9 mm	S	0222050300	3,00 m	50	150,00	80
INOSTOP	0422	9 mm	S	0422025250	2,50 m	25	62,50	160
	0422	9 mm	S	0422025300	3,00 m	25	75,00	160
ALUSTOP COLOR (blanc cassé/gebroken wit)*	9922	9 mm	S	9922001250	2,50 m	10	25,00	40
ALUSTOP COLOR (beige clair/licht beige)*	9922	9 mm		9922002250	2,50 m	10	25,00	40
ALUSTOP COLOR (beige sable/zand beige)*	9922	9 mm		9922003250	2,50 m	10	25,00	40
ALUSTOP COLOR (beige ocre/oker beige)*	9922	9 mm		9922004250	2,50 m	10	25,00	40
ALUSTOP COLOR (beige saumon/zalm beige)*	9922	9 mm		9922005250	2,50 m	10	25,00	40
ALUSTOP COLOR (beige gris/grijs beige)*	9922	9 mm		9922006250	2,50 m	10	25,00	40
ALUSTOP COLOR (bleu clair/licht blauw)*	9922	9 mm		9922007250	2,50 m	10	25,00	40
ALUSTOP COLOR (rose clair/licht rose)*	9922	9 mm		9922008250	2,50 m	10	25,00	40
ALUSTOP COLOR (gris ciment/cement grijs)*	9922	9 mm		9922009250	2,50 m	10	25,00	40
ALUSTOP COLOR (rouge corail/koraal rood)*	9922	9 mm		9922010250	2,50 m	10	25,00	40

\* Commande min. 1 pal. / Min. bestelling 1 pal.

## PROFILÉS D'ARRÊT STOP- & AFWERKPROFIELEN

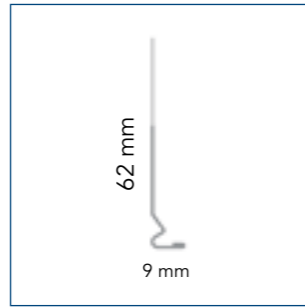
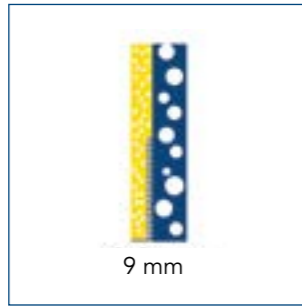

NOM NAAM	EP. D'ENDUIT PLEISTERDIKTE	STOCK STOCK	NR ARTICLE ARTIKEL NR	DIMENSION AFMETING	PIÈCES/EMB. STUKS/VERP.	ML/EMB. LM/VERP.	EMB./PAL. VERP./PAL.	
STOPINOX	0420	9 mm	S	0420025300	3,00 m	25	75,00	80

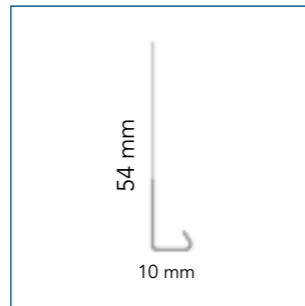
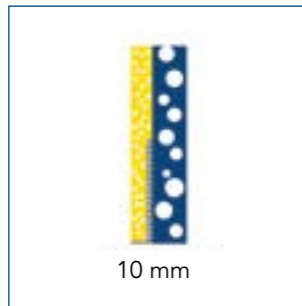

NOM NAAM	EP. D'ENDUIT PLEISTERDIKTE	STOCK STOCK	NR ARTICLE ARTIKEL NR	DIMENSION AFMETING	PIÈCES/EMB. STUKS/VERP.	ML/EMB. LM/VERP.	EMB./PAL. VERP./PAL.	
STOPINOX	0423	10 mm		0423025300	3,00 m	25	75,00	80

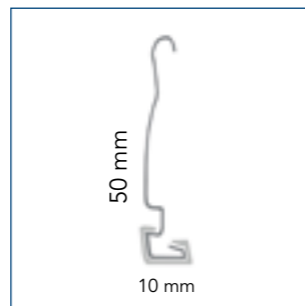
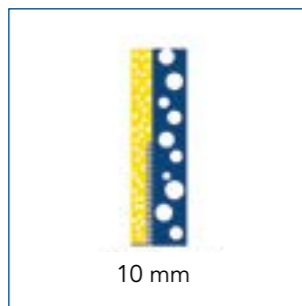

NOM NAAM	EP. D'ENDUIT PLEISTERDIKTE	STOCK STOCK	NR ARTICLE ARTIKEL NR	DIMENSION AFMETING	PIÈCES/EMB. STUKS/VERP.	ML/EMB. LM/VERP.	EMB./PAL. VERP./PAL.	
GALSTOP PVC	2004	10 mm	S	2004010300	3,00 m	10	30,00	80
GALSTOP PVC COLOR (gris/grijs)	9160	10 mm	S	9160009300	3,00 m	10	30,00	80
GALSTOP PVC COLOR (beige)	9160	10 mm	S	9160013300	3,00 m	10	30,00	80

## PROFILÉS D'ARRÊT STOP- & AFWERKPROFIELEN

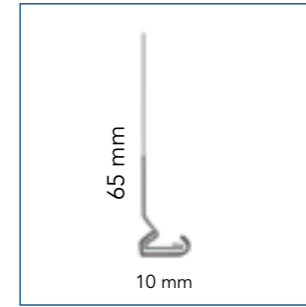
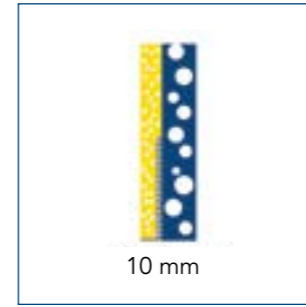

NOM NAAM	EP. D'ENDUIT PLEISTERDIKTE	STOCK STOCK	NR ARTICLE ARTIKEL NR	DIMENSION AFMETING	PIÈCES/EMB. STUKS/VERP.	ML/EMB. LM/VERP.	EMB./PAL. VERP./PAL.	
STOP PVC	2012	10 mm	S	2012025300	3,00 m	25	75,00	80

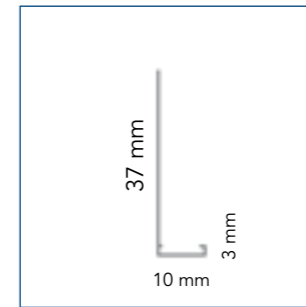
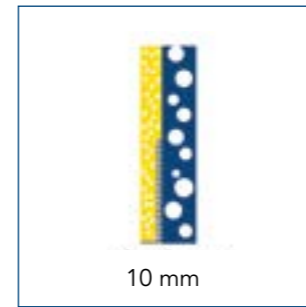

NOM NAAM	EP. D'ENDUIT PLEISTERDIKTE	STOCK STOCK	NR ARTICLE ARTIKEL NR	DIMENSION AFMETING	PIÈCES/EMB. STUKS/VERP.	ML/EMB. LM/VERP.	EMB./PAL. VERP./PAL.	
STOP BEAD PVC	8610	10 mm	S	8610025250	2,50 m	25	62,50	40
STOP BEAD PVC (gris/grijs)	9610	10 mm	S	9610025250	2,50 m	25	62,50	40
STOP BEAD PVC (beige)	9611	10 mm		9611025250	2,50 m	25	62,50	40

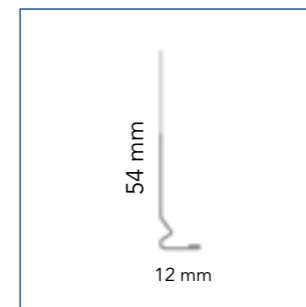
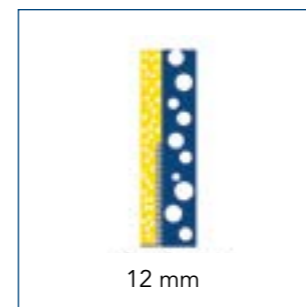

NOM NAAM	EP. D'ENDUIT PLEISTERDIKTE	STOCK STOCK	NR ARTICLE ARTIKEL NR	DIMENSION AFMETING	PIÈCES/EMB. STUKS/VERP.	ML/EMB. LM/VERP.	EMB./PAL. VERP./PAL.	
STOP ALU	0224	12 mm	S	0224025300	3,00 m	25	75,00	80
STOPINOX	0421	12 mm	S	0421025300	3,00 m	25	75,00	80

## PROFILÉS D'ARRÊT STOP- & AFWERKPROFIELEN

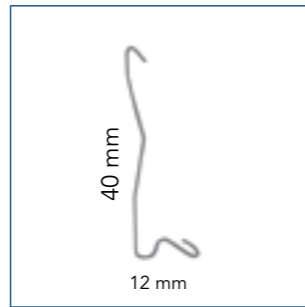
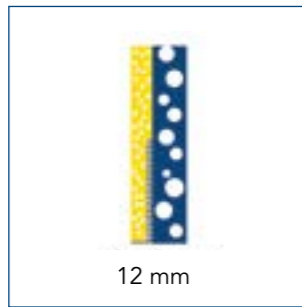

NOM NAAM	EP. D'ENDUIT PLEISTERDIKTE	STOCK STOCK	NR ARTICLE ARTIKEL NR	DIMENSION AFMETING	PIÈCES/EMB. STUKS/VERP.	ML/EMB. LM/VERP.	EMB./PAL. VERP./PAL.	
ALUSTOP	0262	12 mm	S	0262040300	3,00 m	40	120,00	80
INOSTOP	0462	12 mm	S	0462025300	3,00 m	25	75,00	80

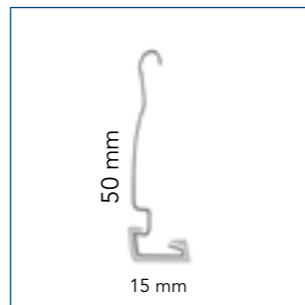
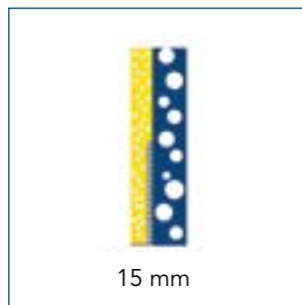

NOM NAAM	EP. D'ENDUIT PLEISTERDIKTE	STOCK STOCK	NR ARTICLE ARTIKEL NR	DIMENSION AFMETING	PIÈCES/EMB. STUKS/VERP.	ML/EMB. LM/VERP.	EMB./PAL. VERP./PAL.	
GALSTOP PVC	2005	15 mm	S	2005010300	3,00 m	10	30,00	80
GALSTOP PVC COLOR (gris/grijs)	9165	15 mm		9165009300	3,00 m	10	30,00	80
GALSTOP PVC COLOR (beige)	9165	15 mm		9165003300	3,00 m	10	30,00	80

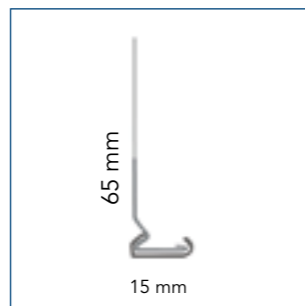
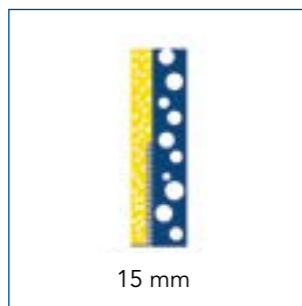

NOM NAAM	EP. D'ENDUIT PLEISTERDIKTE	STOCK STOCK	NR ARTICLE ARTIKEL NR	DIMENSION AFMETING	PIÈCES/EMB. STUKS/VERP.	ML/EMB. LM/VERP.	EMB./PAL. VERP./PAL.	
STOP PVC	2013	15 mm	S	2013025300	3,00 m	25	75,00	80

## PROFILÉS D'ARRÊT STOP- & AFWERKPROFIELEN

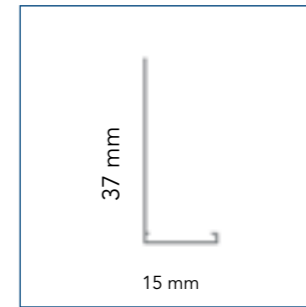
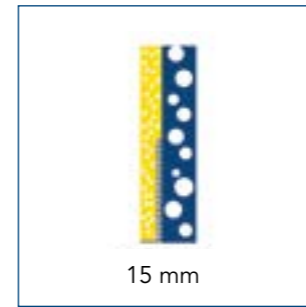

NOM NAAM	EP. D'ENDUIT PLEISTERDIKTE	STOCK STOCK	NR ARTICLE ARTIKEL NR	DIMENSION AFMETING	PIÈCES/EMB. STUKS/VERP.	ML/EMB. LM/VERP.	EMB./PAL. VERP./PAL.	
STOP BEAD PVC	8615	15 mm	S	8615025250	2,50 m	25	62,50	40
STOP BEAD PVC (gris/grijs)	9615	15 mm	S	9615025250	2,50 m	25	62,50	40
STOP BEAD PVC (beige)	9616	15 mm		9616025250	2,50 m	25	62,50	40

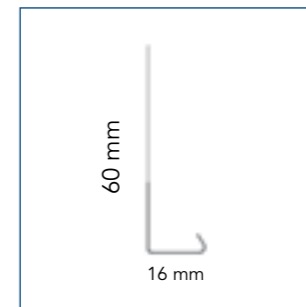
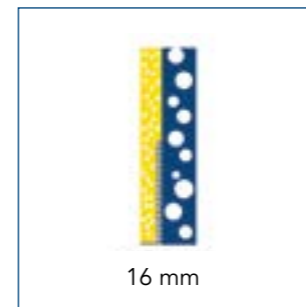

NOM NAAM	EP. D'ENDUIT PLEISTERDIKTE	STOCK STOCK	NR ARTICLE ARTIKEL NR	DIMENSION AFMETING	PIÈCES/EMB. STUKS/VERP.	ML/EMB. LM/VERP.	EMB./PAL. VERP./PAL.	
STOPINOX	0424	16 mm		0424025300	3,00 m	25	75,00	80

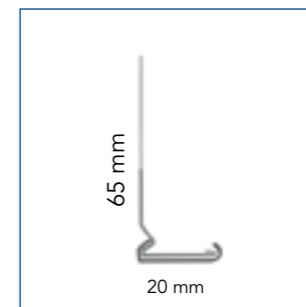
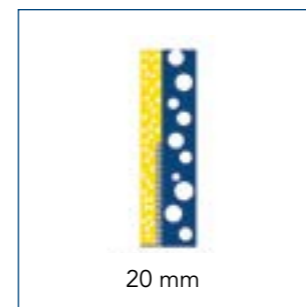

NOM NAAM	EP. D'ENDUIT PLEISTERDIKTE	STOCK STOCK	NR ARTICLE ARTIKEL NR	DIMENSION AFMETING	PIÈCES/EMB. STUKS/VERP.	ML/EMB. LM/VERP.	EMB./PAL. VERP./PAL.	
STOP PVC	2014	20 mm		2014025300	3,00 m	25	75,00	80

## PROFILÉS D'ARRÊT STOP- & AFWERKPROFIELEN

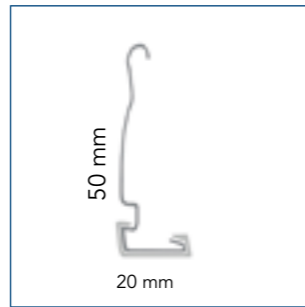
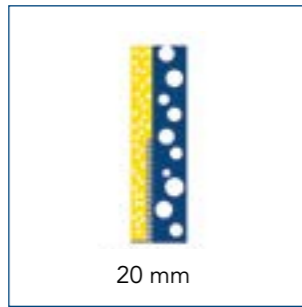

NOM NAAM	EP. D'ENDUIT PLEISTERDIKTE	STOCK STOCK	NR ARTICLE ARTIKEL NR	DIMENSION AFMETING	PIÈCES/EMB. STUKS/VERP.	ML/EMB. LM/VERP.	EMB./PAL. VERP./PAL.
GALSTOP PVC	2170	20 mm	2170025300	3,00 m	25	75,00	80

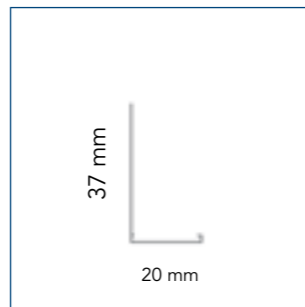
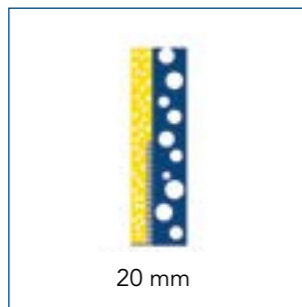

NOM NAAM	EP. D'ENDUIT PLEISTERDIKTE	STOCK STOCK	NR ARTICLE ARTIKEL NR	DIMENSION AFMETING	PIÈCES/EMB. STUKS/VERP.	ML/EMB. LM/VERP.	EMB./PAL. VERP./PAL.
STOP BEAD PVC	8620	20 mm	8620025250	2,50 m	25	62,50	40

## PROFILÉS DE SOUBASSEMENT ONDERMUREN PROFIELEN

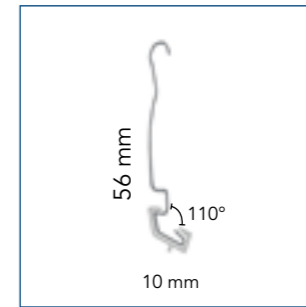
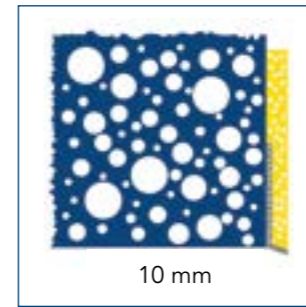

NOM NAAM	EP. D'ENDUIT PLEISTERDIKTE	STOCK STOCK	NR ARTICLE ARTIKEL NR	DIMENSION AFMETING	PIÈCES/EMB. STUKS/VERP.	ML/EMB. LM/VERP.	EMB./PAL. VERP./PAL.	
REND PERFO PVC	2006	10 mm	S	2006010300	3,00 m	10	30,00	80

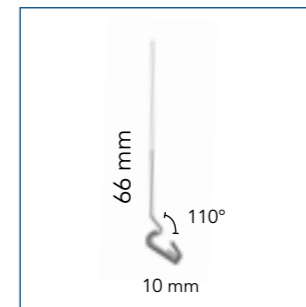
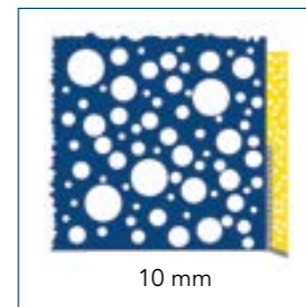

NOM NAAM	EP. D'ENDUIT PLEISTERDIKTE	STOCK STOCK	NR ARTICLE ARTIKEL NR	DIMENSION AFMETING	PIÈCES/EMB. STUKS/VERP.	ML/EMB. LM/VERP.	EMB./PAL. VERP./PAL.	
REND PVC	2008	10 mm		2008025300	3,00 m	25	75,00	80

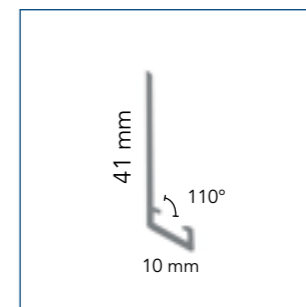
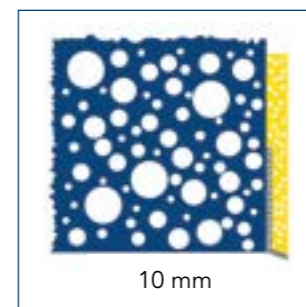

NOM NAAM	EP. D'ENDUIT PLEISTERDIKTE	STOCK STOCK	NR ARTICLE ARTIKEL NR	DIMENSION AFMETING	PIÈCES/EMB. STUKS/VERP.	ML/EMB. LM/VERP.	EMB./PAL. VERP./PAL.	
REND BEAD PVC	8710	10 mm		8710025250	2,50 m	25	62,50	40
REND BEAD PVC (gris/grijs)	9710	10 mm		9710025250	2,50 m	25	62,50	40
REND BEAD PVC (beige)	9711	10 mm		9711025250	2,50 m	25	62,50	40



## PROFILÉS DE SOUBASSEMENT ONDERMUREN PROFIELEN

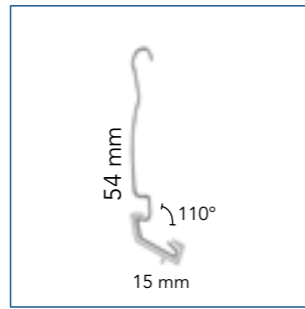
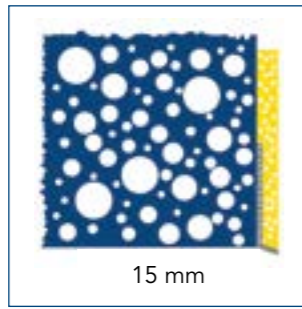

NOM NAAM	EP. D'ENDUIT PLEISTERDIKTE	STOCK STOCK	NR ARTICLE ARTIKEL NR	DIMENSION AFMETING	PIÈCES/EMB. STUKS/VERP.	ML/EMB. LM/VERP.	EMB./PAL. VERP./PAL.	
REND PERFO PVC	2007	15 mm	S	2007010300	3,00 m	10	30,00	80

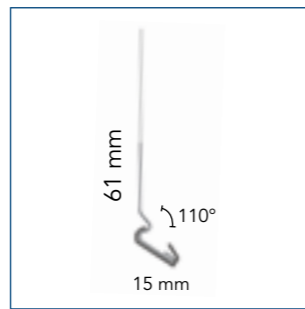
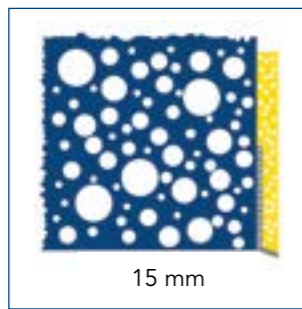

NOM NAAM	EP. D'ENDUIT PLEISTERDIKTE	STOCK STOCK	NR ARTICLE ARTIKEL NR	DIMENSION AFMETING	PIÈCES/EMB. STUKS/VERP.	ML/EMB. LM/VERP.	EMB./PAL. VERP./PAL.	
REND PVC	2009	15 mm		2009025300	3,00 m	25	75,00	80

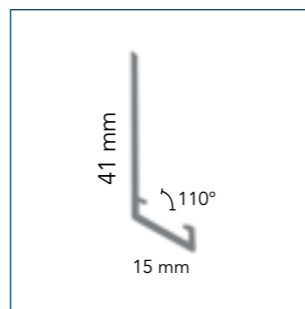
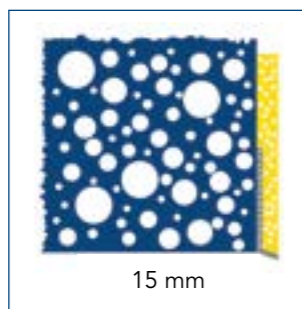

NOM NAAM	EP. D'ENDUIT PLEISTERDIKTE	STOCK STOCK	NR ARTICLE ARTIKEL NR	DIMENSION AFMETING	PIÈCES/EMB. STUKS/VERP.	ML/EMB. LM/VERP.	EMB./PAL. VERP./PAL.	
REND BEAD PVC	8715	15 mm		8715025250	2,50 m	25	62,50	40
REND BEAD PVC (gris/grijs)	9715	15 mm		9715025250	2,50 m	25	62,50	40
REND BEAD PVC (beige)	9716	15 mm		9716025250	2,50 m	25	62,50	40

## PROFILÉS DE SOUBASSEMENT ONDERMUREN PROFIELEN

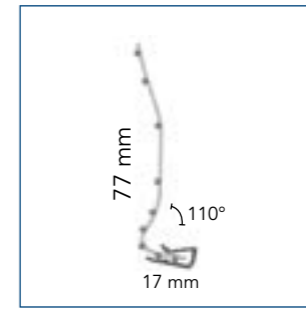
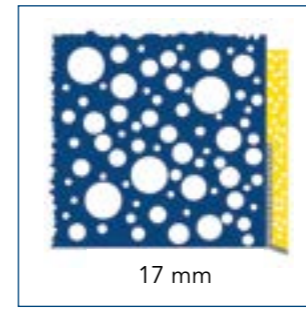
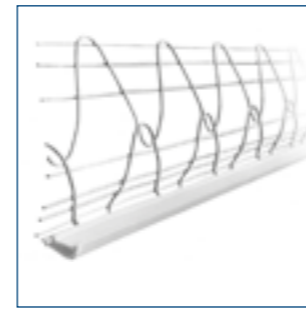

NOM NAAM	EP. D'ENDUIT PLEISTERDIKTE	STOCK STOCK	NR ARTICLE ARTIKEL NR	DIMENSION AFMETING	PIÈCES/EMB. STUKS/VERP.	ML/EMB. LM/VERP.	EMB./PAL. VERP./PAL.	
WIDRA APHK	0179	17 mm		0179020295	2,95 m	20	59,00	36

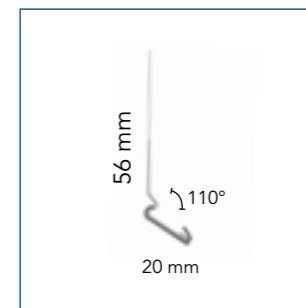
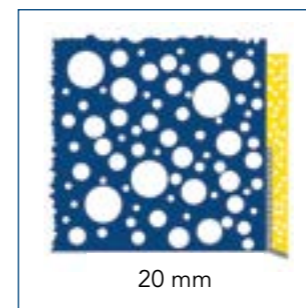

NOM NAAM	EP. D'ENDUIT PLEISTERDIKTE	STOCK STOCK	NR ARTICLE ARTIKEL NR	DIMENSION AFMETING	PIÈCES/EMB. STUKS/VERP.	ML/EMB. LM/VERP.	EMB./PAL. VERP./PAL.	
REND PVC	2010	20 mm		2010025300	3,00 m	25	75,00	80

## PROFILÉS D'ÉPAISSEUR AFSTRIJKPROFIELEN

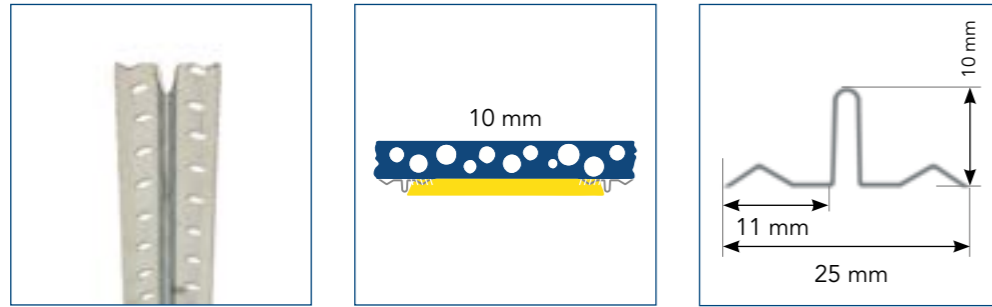

NOM NAAM	EP. D'ENDUIT PLEISTERDIKTE	STOCK STOCK	NR ARTICLE ARTIKEL NR	DIMENSION AFMETING	PIÈCES/EMB. STUKS/VERP.	ML/EMB. LM/VERP.	EMB./PAL. VERP./PAL.
REGLALU	0241	10 mm	0241050250	2,50 m	50	125,00	125
	0241	10 mm	0241050260	2,60 m	50	130,00	125
	0241	10 mm	0241050300	3,00 m	50	150,00	125
REGLINOX	0441	10 mm	0441050250	2,50 m	50	125,00	125

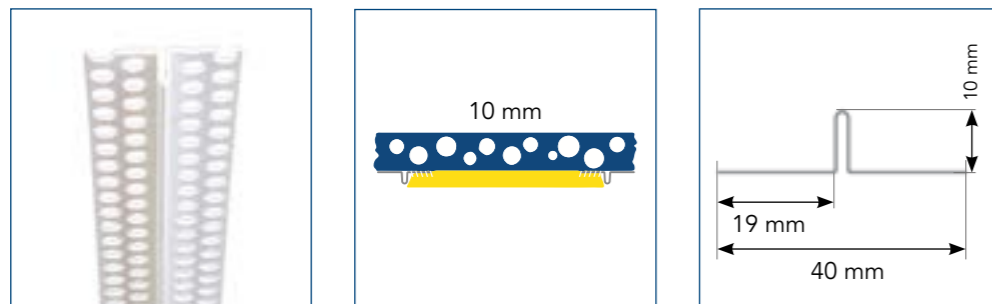

NOM NAAM	EP. D'ENDUIT PLEISTERDIKTE	STOCK STOCK	NR ARTICLE ARTIKEL NR	DIMENSION AFMETING	PIÈCES/EMB. STUKS/VERP.	ML/EMB. LM/VERP.	EMB./PAL. VERP./PAL.
REGLE PVC	8032	10 mm	8032050300	3,00 m	50	150,00	100

## PROFILÉS DE DILATATION UITZETTINGSPROFIELEN

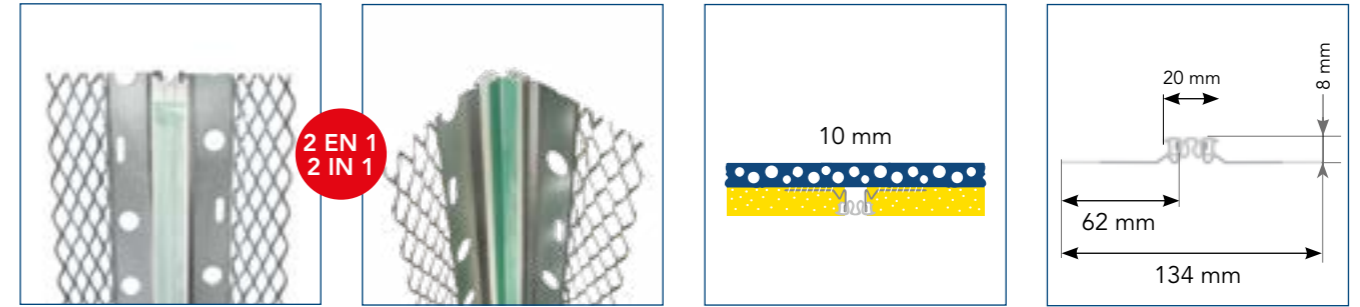

NOM NAAM	EP. D'ENDUIT PLEISTERDIKTE	STOCK STOCK	NR ARTICLE ARTIKEL NR	DIMENSION AFMETING	PIÈCES/EMB. STUKS/VERP.	ML/EMB. LM/VERP.	EMB./PAL. VERP./PAL.
DILATGAL	2001	10 mm	2001010300	3,00 m	10	30,00	54
DILATGAL COLOR (beige)	9001	10 mm	9001010300	3,00 m	10	30,00	54
DILATINOX	2401	10 mm	2401010300	3,00 m	10	30,00	54
DILATINOX COLOR (beige)	9401	10 mm	9401010300	3,00 m	10	30,00	54

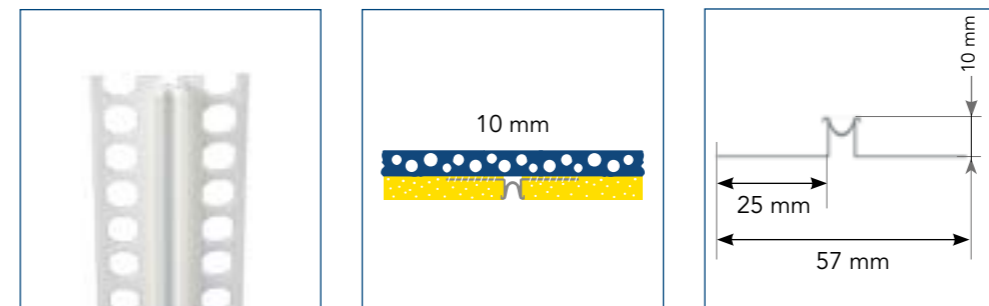

NOM NAAM	EP. D'ENDUIT PLEISTERDIKTE	STOCK STOCK	NR ARTICLE ARTIKEL NR	DIMENSION AFMETING	PIÈCES/EMB. STUKS/VERP.	ML/EMB. LM/VERP.	EMB./PAL. VERP./PAL.
DILAT PVC	8510	10 mm	8510025250	2,50 m	25	62,50	40
DILAT PVC (gris/grijs)	9510	10 mm	9510025250	2,50 m	25	62,50	40
DILAT PVC (beige)	9511	10 mm	9511025250	2,50 m	25	62,50	40

## PROFILÉS DE DILATATION UITZETTINGSPROFIELEN

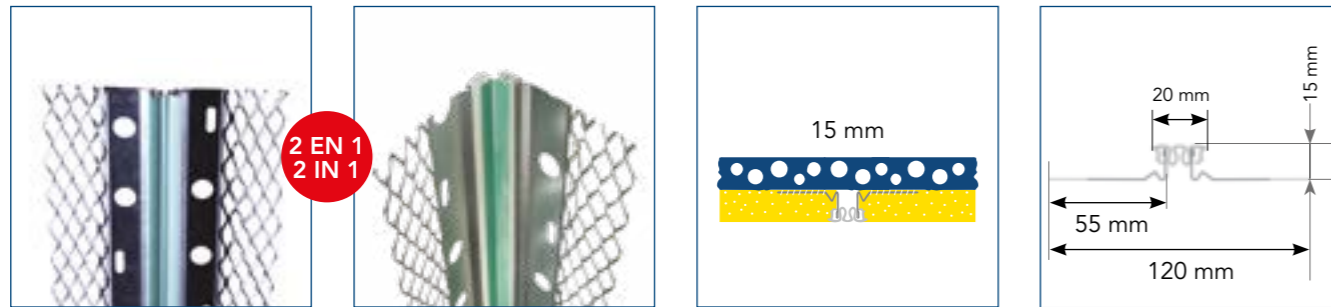

NOM NAAM		EP. D'ENDUIT PLEISTERDIKTE	STOCK STOCK	NR ARTICLE ARTIKEL NR	DIMENSION AFMETING	PIÈCES/EMB. STUKS/VERP.	ML/EMB. LM/VERP.	EMB./PAL. VERP/PAL.
DILATGAL	2002	15 mm		2002010300	3,00 m	10	30,00	54
DILATGAL COLOR (beige)	9002	15 mm		9002010300	3,00 m	10	30,00	54
DILATINOX	2402	15 mm		2402010300	3,00 m	10	30,00	54
DILATINOX COLOR (beige)	9402	15 mm		9402010300	3,00 m	10	30,00	54

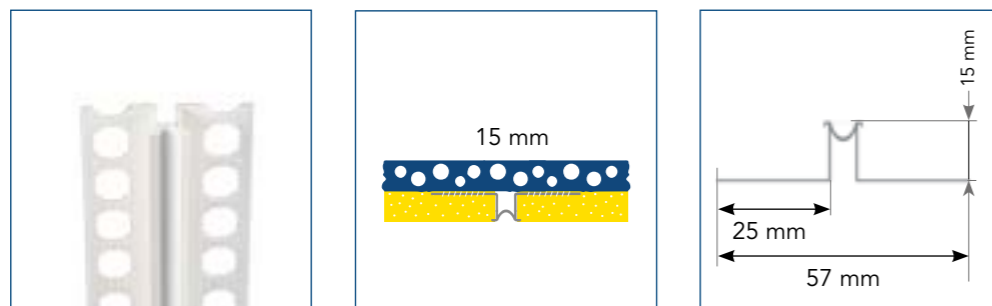

NOM NAAM		EP. D'ENDUIT PLEISTERDIKTE	STOCK STOCK	NR ARTICLE ARTIKEL NR	DIMENSION AFMETING	PIÈCES/EMB. STUKS/VERP.	ML/EMB. LM/VERP.	EMB./PAL. VERP/PAL.
DILAT PVC	8515	15 mm	S	8515025250	2,50 m	25	62,50	40
DILAT PVC (gris/grijs)	9515	15 mm		9515025250	2,50 m	25	62,50	40
DILAT PVC (beige)	9516	15 mm		9516025250	2,50 m	25	62,50	40

## PROFILÉS DE DILATATION UITZETTINGSPROFIELEN

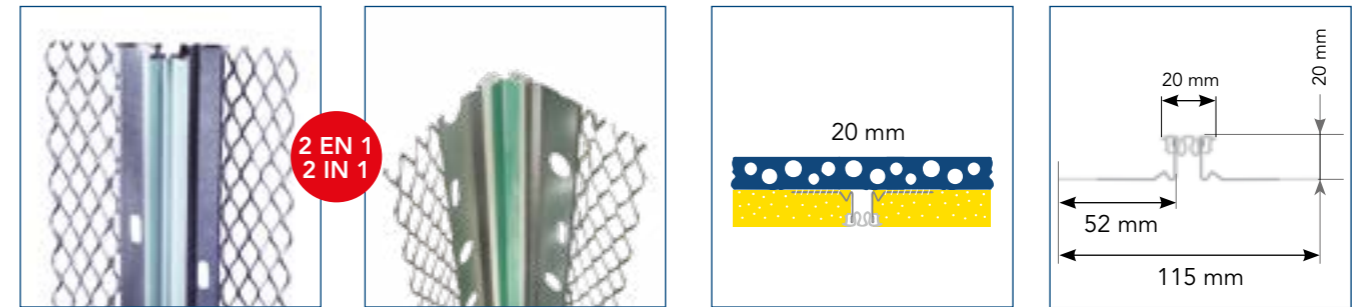

NOM NAAM		EP. D'ENDUIT PLEISTERDIKTE	STOCK STOCK	NR ARTICLE ARTIKEL NR	DIMENSION AFMETING	PIÈCES/EMB. STUKS/VERP.	ML/EMB. LM/VERP.	EMB./PAL. VERP/PAL.
DILATGAL	2003	20 mm		2003010300	3,00 m	10	30,00	54
DILATGAL COLOR (beige)	9003	20 mm		9003010300	3,00 m	10	30,00	54

## COUVRE JOINTS VOEGAFDEKKINGSPROFIELEN



NOM NAAM	STOCK STOCK	N° ARTICLE ARTIKEL NR	LARGEUR BREEDETE	LARGEUR JOINT VOEG BREEDETE	DIMENSION AFMETING	PCES/EMB. STUKS/VERP.	ML/EMB. LM/VERP.	CLIPS	CLIPS/LGUEUR CLIPS/LENGTE **
COUVRE JOINT À CLIPSER / VOEG-AFDEKKINGSPROFIEL TE CLIPSEN - ALU (plat/vlak) *	2201	2201050300	50 mm	10 - 35 mm	3,00 m	10	30,00	S	4
	2203	2203070300	70 mm	35 - 50 mm	3,00 m	10	30,00	S	4
		2203071300						SLL	
	2204	2204090300	90 mm	40 - 70 mm	3,00 m	10	30,00	S	4
		2204091300						SLL	
2205	2205121300	120 mm	60 - 90 mm	3,00 m	10	30,00	SLL	4	
	2205122300						XL		

\* Aluminium anodisé incolore - Autres couleurs sur demande / Kleurloos geanodiseerd aluminium - Andere kleuren op aanvraag  
\*\* Pour murs et plafonds / Voor wanden en plafonds

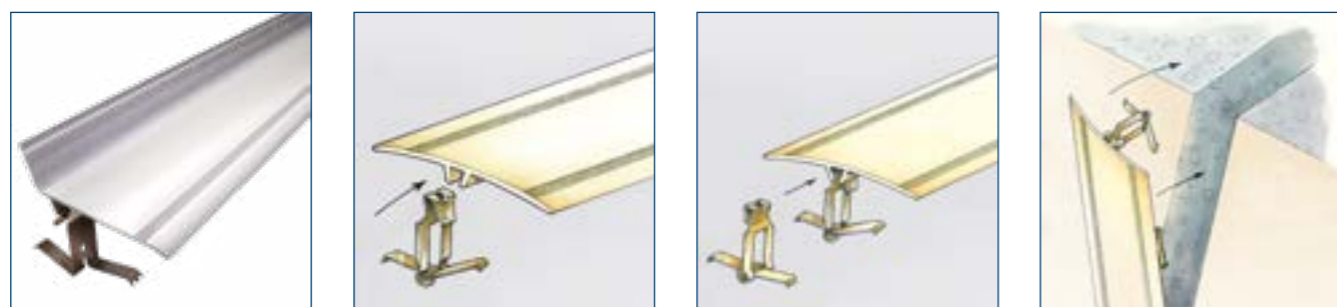

NOM NAAM	STOCK STOCK	N° ARTICLE ARTIKEL NR	LARGEUR BREEDETE	LARGEUR JOINT VOEG BREEDETE	DIMENSION AFMETING	PCES/EMB. STUKS/VERP.	ML/EMB. LM/VERP.	CLIPS	CLIPS/LGUEUR CLIPS/LENGTE **
COUVRE JOINT À CLIPSER / VOEG-AFDEKKINGSPROFIEL TE CLIPSEN - ALU (coin intérieur/binnenhoek 90°) *	2211	2211050300	50 mm	10 - 35 mm	3,00 m	10	30,00	S	4
	2213	2213070300	70 mm	35 - 50 mm	3,00 m	10	30,00	S	4
		2213071300						SLL	
	2214	2214090300	90 mm	40 - 70 mm	3,00 m	10	30,00	S	4
		2214091300						SLL	
2215	2215121300	120 mm	60 - 90 mm	3,00 m	10	30,00	SLL	4	
	2215122300						XL		

\* Aluminium anodisé incolore - Autres couleurs sur demande / Kleurloos geanodiseerd aluminium - Andere kleuren op aanvraag  
\*\* Pour murs et plafonds / Voor wanden en plafonds

## COUVRE JOINTS VOEGAFDEKKINGSPROFIELEN

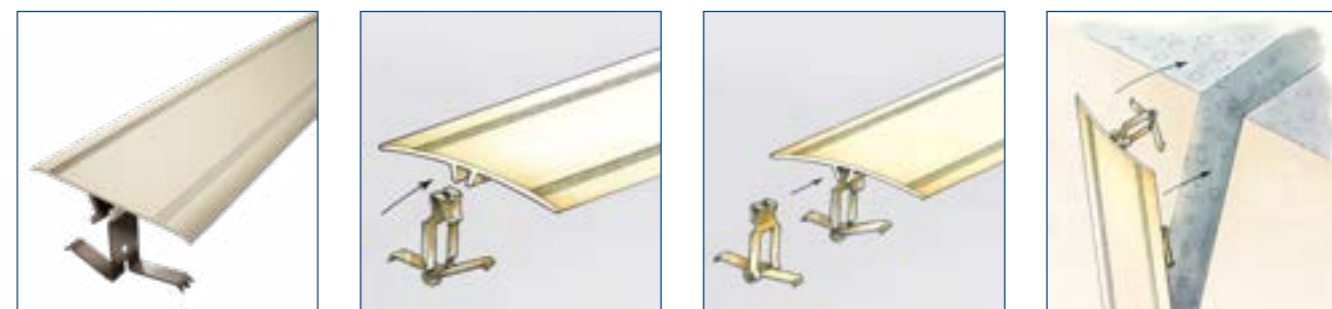

NOM NAAM	STOCK STOCK	N° ARTICLE ARTIKEL NR	LARGEUR BREEDETE	LARGEUR JOINT VOEG BREEDETE	DIMENSION AFMETING	PCES/EMB. STUKS/VERP.	ML/EMB. LM/VERP.	CLIPS	CLIPS/LGUEUR CLIPS/LENGTE **	
COUVRE JOINT À CLIPSER / VOEG-AFDEKKINGSPROFIEL TE CLIPSEN - PVC (plat/vlak) *	2801	2801050300	50 mm	10 - 35 mm	3,00 m	10	30,00	S	5	
		2803	2803070300	70 mm	35 - 50 mm	3,00 m	10	30,00	S	5
			2803071300					30,00	SLL	
		2804	2804090300	90 mm	40 - 70 mm	3,00 m	10	30,00	S	5
2804091300	30,00		SLL							

\* RAL 9016 (blanc/wit) - 1015 (beige) - 7035 (gris/grijs) - Autres couleurs sur demande / Andere kleuren op aanvraag  
\*\* Pour murs et plafonds / Voor wanden en plafonds

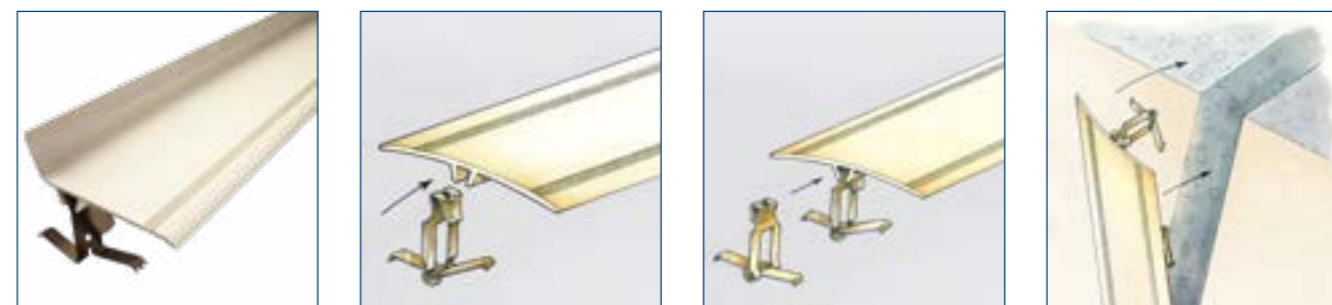

NOM NAAM	STOCK STOCK	N° ARTICLE ARTIKEL NR	LARGEUR BREEDETE	LARGEUR JOINT VOEG BREEDETE	DIMENSION AFMETING	PCES/EMB. STUKS/VERP.	ML/EMB. LM/VERP.	CLIPS	CLIPS/LGUEUR CLIPS/LENGTE **	
COUVRE JOINT À CLIPSER / VOEG-AFDEKKINGSPROFIEL TE CLIPSEN - PVC (coin intérieur/binnenhoek 90°) *	2811	2811050300	50 mm	10 - 35 mm	3,00 m	10	30,00	S	5	
		2813	2813070300	70 mm	35 - 50 mm	3,00 m	10	30,00	S	5
			2813071300					30,00	SLL	
		2814	2814090300	90 mm	40 - 70 mm	3,00 m	10	30,00	S	5
2814091300	30,00		SLL							

\* RAL 9016 (blanc/wit) - 1015 (beige) - 7035 (gris/grijs) - Autres couleurs sur demande / Andere kleuren op aanvraag  
\*\* Pour murs et plafonds / Voor wanden en plafonds

## ACCESSOIRES POUR COUVRE JOINTS TOEBEHOREN VOOR VOEGAFDEKKINGSPROFIELEN

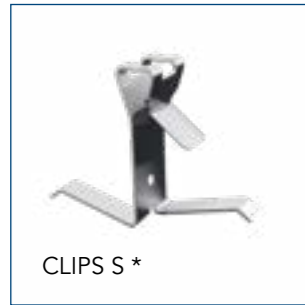

CLIPS S \*



CLIPS SLL \*



CLIPS XL \*

NOM NAAM	STOCK STOCK	N° ARTICLE ARTIKEL NR	LARGEUR JOINT VOEG BREEDTE	PCES/EMB. STUKS/VERP.
CLIPS S *	1440	1440010035	10 - 35 mm	50
CLIPS SLL *	1441	1441035080	35 - 80 mm	50
CLIPS XL *	1442	1442060100	60 - 100 mm	1

## PROFILÉS PVC POUR PORTES & FENÊTRES PVC AFWERKPROFIELEN VOOR DEUREN & RAMEN

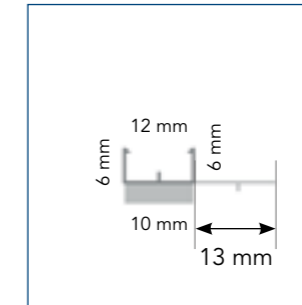
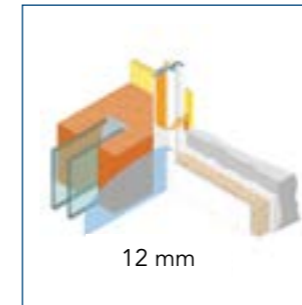

NOM NAAM	EP. D'ENDUIT PLEISTERDIKTE	STOCK STOCK	NR ARTICLE ARTIKEL NR	DIMENSION AFMETING	PIÈCES/EMB. STUKS/VERP.	ML/EMB. LM/VERP.	EMB./PAL. VERP./PAL.
APU A13 / MIDI	8112		8112030140	1,40 m	30	42,00	100
	8112	S	8112030240	2,40 m	30	72,00	100

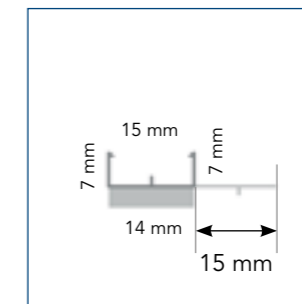
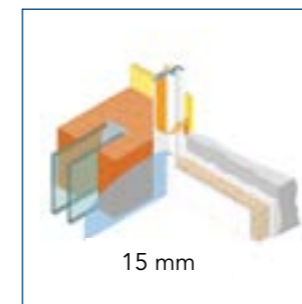

NOM NAAM	EP. D'ENDUIT PLEISTERDIKTE	STOCK STOCK	NR ARTICLE ARTIKEL NR	DIMENSION AFMETING	PIÈCES/EMB. STUKS/VERP.	ML/EMB. LM/VERP.	EMB./PAL. VERP./PAL.
APU A14 / UNIVERSAL	8115		8115030140	1,40 m	30	42,00	100
	8115	S	8115030240	2,40 m	30	72,00	100

Demandez-nous  
le catalogue complet  
**APU®**

Vraag onze  
**APU®**  
catalogus

[www.apu.ch](http://www.apu.ch)



## SUPPORTS POUR ENDUITS PLEISTERDRAGERS

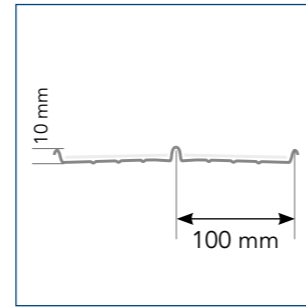
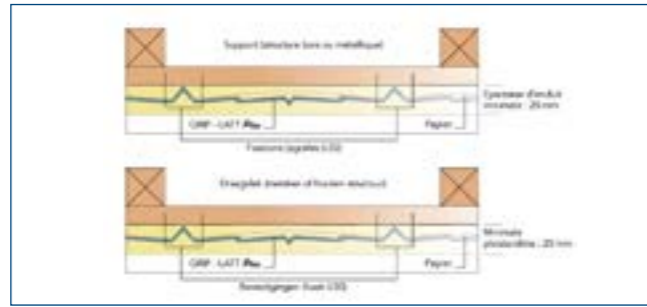

NOM NAAM	EP. D'ENDUIT PLEISTERDIKTE	STOCK STOCK	NR ARTICLE ARTIKEL NR	DIMENSION AFMETING	PIÈCES/EMB. STUKS/VERP.	ML/EMB. LM/VERP.	EMB./PAL. VERP./PAL.
GRIP-LATT PLUS 6000	20 mm	S	6000015250	0,60 X 2,50 m	15	22,50 m <sup>2</sup>	30

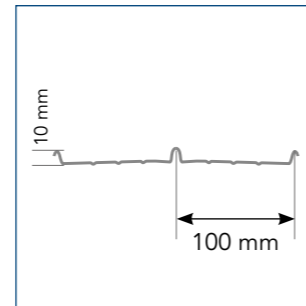
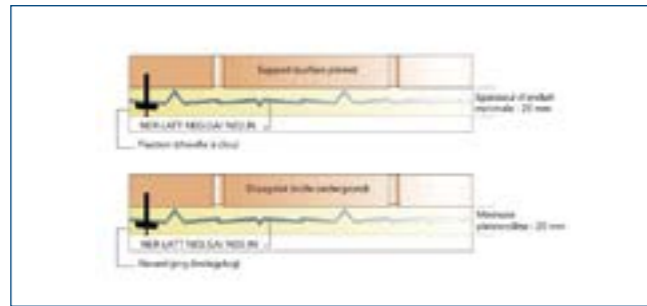

NOM NAAM	EP. D'ENDUIT PLEISTERDIKTE	STOCK STOCK	NR ARTICLE ARTIKEL NR	DIMENSION AFMETING	PIÈCES/EMB. STUKS/VERP.	ML/EMB. LM/VERP.	EMB./PAL. VERP./PAL.
NER-LATT 6100	20 mm	S	6100015250	0,60 X 2,50 m	15	22,50 m <sup>2</sup>	50
NER-LATT INOX 6400	20 mm	S	6400010250	0,60 X 2,50 m	10	15 m <sup>2</sup>	50

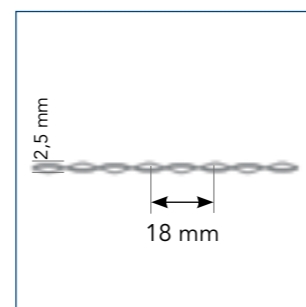
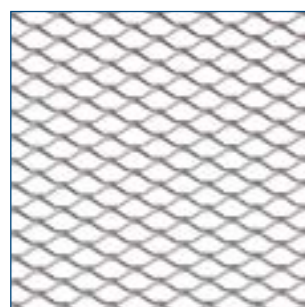

NOM NAAM	EP. D'ENDUIT PLEISTERDIKTE	STOCK STOCK	NR ARTICLE ARTIKEL NR	DIMENSION AFMETING	PIÈCES/EMB. STUKS/VERP.	ML/EMB. LM/VERP.	EMB./PAL. VERP./PAL.
GALTO 6018	25 mm	S	6018001250	1 X 25 m	1	25 m <sup>2</sup>	20
GALTO INOX 6418	25 mm	S	6418001250	1 X 25 m	1	25 m <sup>2</sup>	20

## SUPPORTS POUR ENDUITS PLEISTERDRAGERS

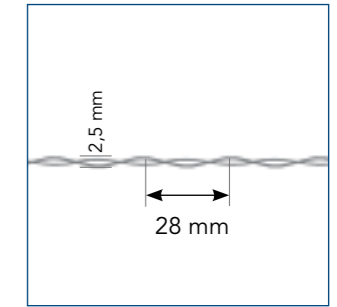
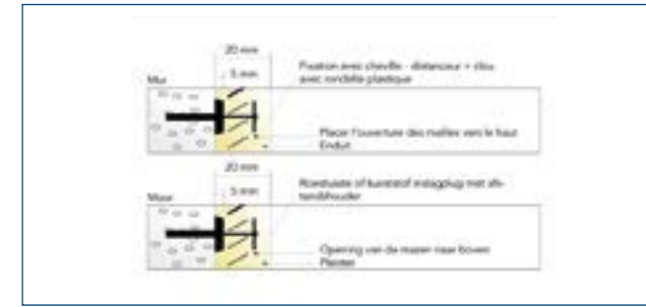
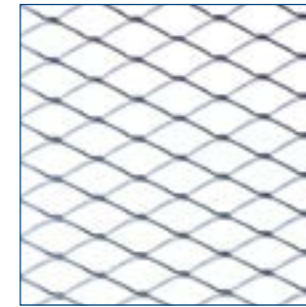

NOM NAAM	EP. D'ENDUIT PLEISTERDIKTE	STOCK STOCK	NR ARTICLE ARTIKEL NR	DIMENSION AFMETING	PIÈCES/EMB. STUKS/VERP.	ML/EMB. LM/VERP.	EMB./PAL. VERP./PAL.
GALTO 6028	25 mm	S	6028001250	1 X 25 m	1	25 m <sup>2</sup>	20
GALTO INOX 6428	25 mm		6428001250	1 X 25 m	1	25 m <sup>2</sup>	20

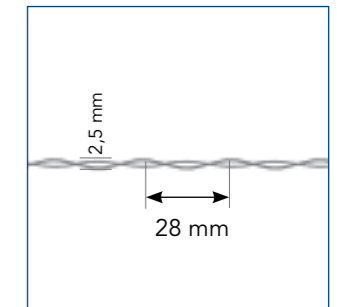
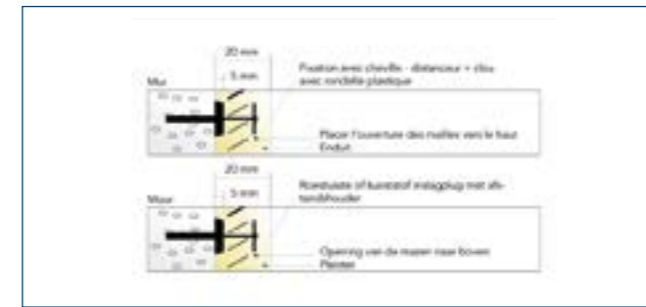
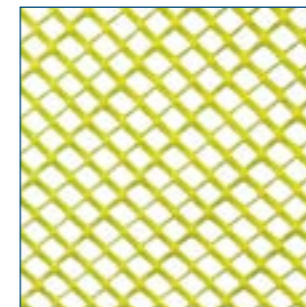

NOM NAAM	EP. D'ENDUIT PLEISTERDIKTE	STOCK STOCK	NR ARTICLE ARTIKEL NR	DIMENSION AFMETING	PIÈCES/EMB. STUKS/VERP.	ML/EMB. LM/VERP.	EMB./PAL. VERP./PAL.
GALTO PVC 6828	25 mm		6828001305	0,715 X 30,5 m	1	21,81 m <sup>2</sup>	18

## FIBRE DE VERRE GLASVEZEL



NOM NAAM	STOCK STOCK	N° ARTICLE ARTIKEL NR	DIMENSION AFMETING	PCES/EMB. STUKS/VERP.	EMB./PAL. VERP./PAL
<b>BALKENFIX</b>	1027	1027001016	50 m X 16,5 cm	1	20
	1028	1028001020	50 m X 20 cm	1	20
	1029	1029001025	50 m X 25 cm	1	20
	1030	1030001033	50 m X 33 cm	1	20

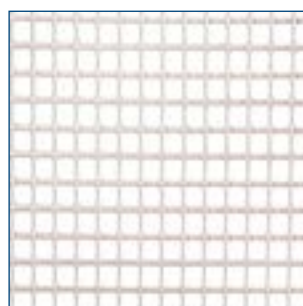

NOM NAAM	STOCK STOCK	N° ARTICLE ARTIKEL NR	DIMENSION AFMETING	PCES/EMB. STUKS/VERP.	EMB./PAL. VERP./PAL
<b>FASSATEX 10x10 (145 gr/m²) - certifié ETAG gecertificeerd</b>	4140 blanc/wit	4140001050	50 m X 100 cm	1	24
	4141 bleu/blauw	4141001050	50 m X 100 cm	1	24
	4142 orange/oranje	4142001050	50 m X 100 cm	1	24
	4143 blanc/wit	4143003050	50 m X 33 cm	3	24
	4144 blanc/wit	4144002050	50 m X 50 cm	2	24
	4145 bleu/blauw	4145003050	50 m X 33 cm	3	24
	4146 bleu/blauw	4146002050	50 m X 50 cm	2	24

## FIBRE DE VERRE GLASVEZEL

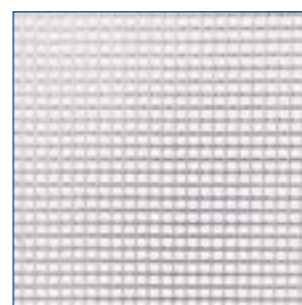

NOM NAAM	STOCK STOCK	N° ARTICLE ARTIKEL NR	DIMENSION AFMETING	PCES/EMB. STUKS/VERP.	EMB./PAL. VERP./PAL
<b>FASSATEX 5x5 (200 gr/m²) - certifié ETAG gecertificeerd</b>	4210 blanc/wit	4210001050	50 m X 100 cm	1	20

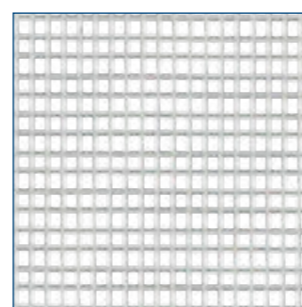

NOM NAAM	STOCK STOCK	N° ARTICLE ARTIKEL NR	DIMENSION AFMETING	PCES/EMB. STUKS/VERP.	EMB./PAL. VERP./PAL
<b>FASSATEX 8x8 (220 gr/m²) - certifié ETAG gecertificeerd</b>	4220 blanc/wit	4220001050	50 m X 100 cm	1	20

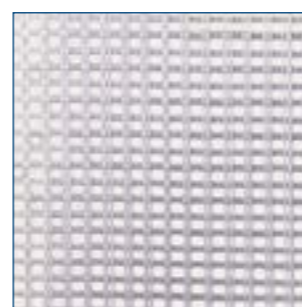

NOM NAAM	STOCK STOCK	N° ARTICLE ARTIKEL NR	DIMENSION AFMETING	PCES/EMB. STUKS/VERP.	EMB./PAL. VERP./PAL
<b>FASSATEX 6x10 (330 gr/m²) - certifié ETAG gecertificeerd</b>	4330 blanc/wit	4330001025	25 m X 100 cm	1	30

## ACCESSOIRES TOEBEHOREN

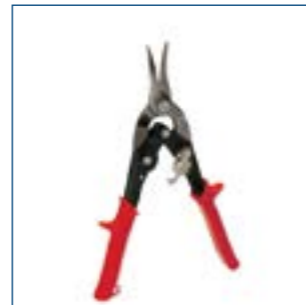
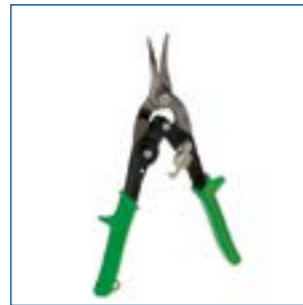

NOM NAAM	STOCK STOCK	NR ARTICLE ARTIKEL NR	DIMENSION AFMETING	PIÈCES/EMB. STUKS/VERP.	EMB./PAL. VERP./PAL.
PINCE POUR PROFILÉS / PROFIEL SCHAAR	1200	1200006000		6	
PINCE POUR PROFILÉS (vert - droitier) / PROFIEL SCHAAR (groen - rechtshandig)	1201	1201005000		5	
PINCE POUR PROFILÉS (rouge - gaucher) / PROFIEL SCHAAR (rood - linkshandig)	1202	1202005000		5	



NOM NAAM	STOCK STOCK	NR ARTICLE ARTIKEL NR	DIMENSION AFMETING	PIÈCES/EMB. STUKS/VERP.	EMB./PAL. VERP./PAL.
PINCE MULTI COUP / MULTI COUP SCHAAR	1205	1205001000		1	

## ACCESSOIRES TOEBEHOREN

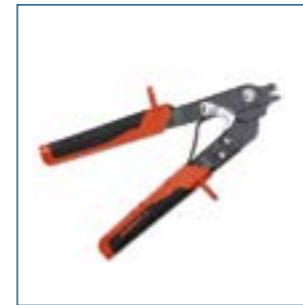

NOM NAAM	STOCK STOCK	NR ARTICLE ARTIKEL NR	DIMENSION AFMETING	PIÈCES/EMB. STUKS/VERP.	EMB./PAL. VERP./PAL.
PINCE A SERTIR / VERBINDINGS- TANG LATT-FIX	1206	S	1206001000	1	



NOM NAAM	STOCK STOCK	NR ARTICLE ARTIKEL NR	DIMENSION AFMETING	PIÈCES/EMB. STUKS/VERP.	EMB./PAL. VERP./PAL.
PINCE GALTO / GALTO SCHAAR	1207		1207001000	1	



NOM NAAM	STOCK STOCK	NR ARTICLE ARTIKEL NR	DIMENSION AFMETING	PIÈCES/EMB. STUKS/VERP.	EMB./PAL. VERP./PAL.
PINCE PVC / PVC SCHAAR APU Z12	1210		1210001000	1	



**NOTES**  
**NOTA**



**FAÇADES ISOLANTES /  
ITE**  
**GEVEL ISOLATIE  
SYSTEMEN**

## PROFILÉS D'ANGLE HOEKPROFIELEN

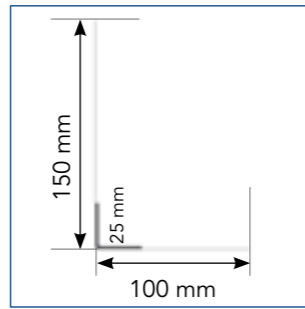

NOM NAAM	EP. D'ENDUIT PLEISTERDIKTE	STOCK STOCK	NR ARTICLE ARTIKEL NR	DIMENSION AFMETING	PIÈCES/EMB. STUKS/VERP.	ML/EMB. LM/VERP.	EMB./PAL. VERP./PAL.	
ALUPLAC GWS	0216	3 mm	S	0216050250	2,50 m	50	125,00	30
INOPLAC GWS	0495	3 mm	S	0495050250	2,50 m	50	125,00	30

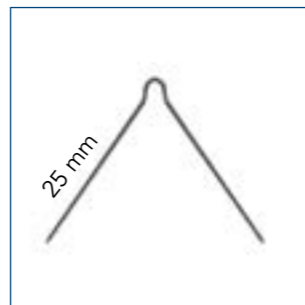

NOM NAAM	EP. D'ENDUIT PLEISTERDIKTE	STOCK STOCK	NR ARTICLE ARTIKEL NR	DIMENSION AFMETING	PIÈCES/EMB. STUKS/VERP.	ML/EMB. LM/VERP.	EMB./PAL. VERP./PAL.	
MINIGYP INOX	0411	3 mm	S	0411025250	2,50 m	25	62,50	160
	0411	3 mm	S	0411025300	3,00 m	25	75,00	160

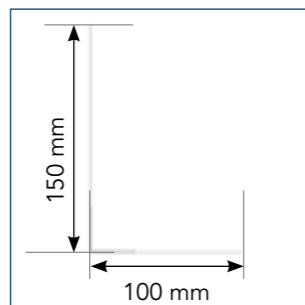

NOM NAAM	EP. D'ENDUIT PLEISTERDIKTE	STOCK STOCK	NR ARTICLE ARTIKEL NR	DIMENSION AFMETING	PIÈCES/EMB. STUKS/VERP.	ML/EMB. LM/VERP.	EMB./PAL. VERP./PAL.	
GWS EXTRA	8113	3 mm		8113050250	2,50 m	50	125,00	30

## PROFILÉS D'ANGLE HOEKPROFIELEN

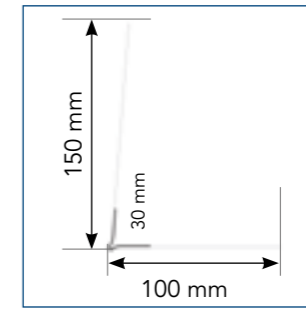
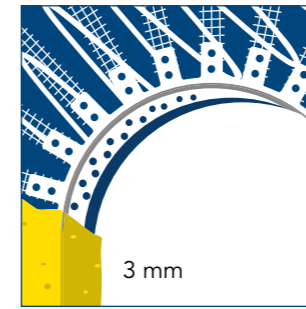

NOM NAAM	EP. D'ENDUIT PLEISTERDIKTE	STOCK STOCK	NR ARTICLE ARTIKEL NR	DIMENSION AFMETING	PIÈCES/EMB. STUKS/VERP.	ML/EMB. LM/VERP.	EMB./PAL. VERP./PAL.	
PER PVC RONDO GWS	8123	3 mm		8123050250	2,50 m	50	125,00	40

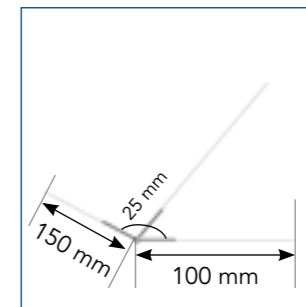
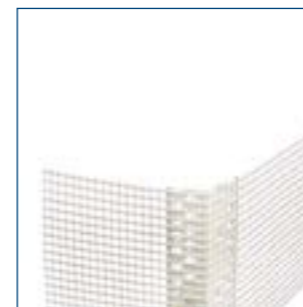

NOM NAAM	EP. D'ENDUIT PLEISTERDIKTE	STOCK STOCK	NR ARTICLE ARTIKEL NR	DIMENSION AFMETING	PIÈCES/EMB. STUKS/VERP.	ML/EMB. LM/VERP.	EMB./PAL. VERP./PAL.	
PER PVC FLEX GWS	8129	3 mm		8129050250	2,50 m	50	125,00	40

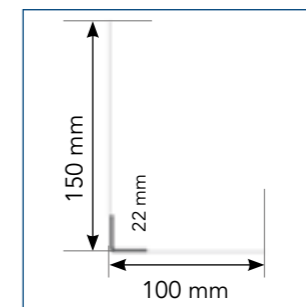

NOM NAAM	EP. D'ENDUIT PLEISTERDIKTE	STOCK STOCK	NR ARTICLE ARTIKEL NR	DIMENSION AFMETING	PIÈCES/EMB. STUKS/VERP.	ML/EMB. LM/VERP.	EMB./PAL. VERP./PAL.	
PER PVC GWS PRO	8211*	3 mm	S	8211050250	2,50 m	50	125,00	26
PER PVC GWS PRO	8212*	3 mm	S	8212050250	2,50 m	50	125,00	26
PER PVC GWS PRO	8213*	3 mm	S	8213050250	2,50 m	50	125,00	26
PER PVC GWS PRO	8214*	3 mm	S	8214050250	2,50 m	50	125,00	26
PER PVC GWS ECO	8413*	3 mm		8413050250	2,50 m	50	125,00	26

\* Couleur de la fibre / Netkleur

## PROFILÉS D'ANGLE HOEKPROFIELEN

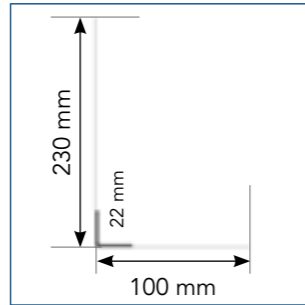

NOM NAAM	EP. D'ENDUIT PLEISTERDIKTE	STOCK STOCK	NR ARTICLE ARTIKEL NR	DIMENSION AFMETING	PIÈCES/EMB. STUKS/VERP.	ML/EMB. LM/VERP.	EMB./PAL. VERP./PAL.
<b>PER PVC GWS PRO 10 X 23 MM (blanc/wit)</b>	3 mm	S	8219025250	2,50 m	25	62,50	22

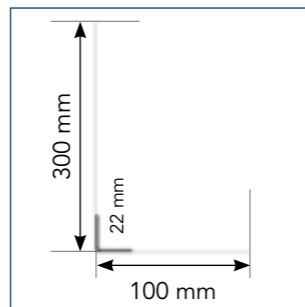

NOM NAAM	EP. D'ENDUIT PLEISTERDIKTE	STOCK STOCK	NR ARTICLE ARTIKEL NR	DIMENSION AFMETING	PIÈCES/EMB. STUKS/VERP.	ML/EMB. LM/VERP.	EMB./PAL. VERP./PAL.
<b>PER PVC GWS PRO 10 X 30 MM (blanc/wit)</b>	3 mm	S	8220025250	2,50 m	25	62,50	22

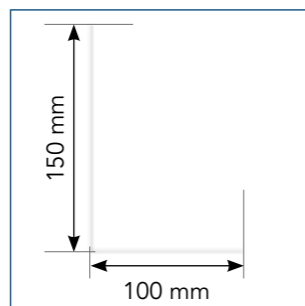
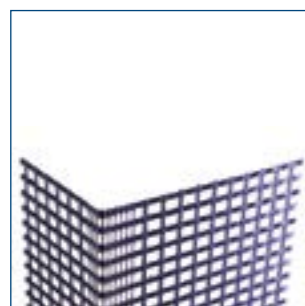

NOM NAAM	EP. D'ENDUIT PLEISTERDIKTE	STOCK STOCK	NR ARTICLE ARTIKEL NR	DIMENSION AFMETING	PIÈCES/EMB. STUKS/VERP.	ML/EMB. LM/VERP.	EMB./PAL. VERP./PAL.
<b>GWS ISOCORNER</b>	3 mm		8313050260	2,60 m	50	130,00	30

## PROFILÉS D'ANGLE HOEKPROFIELEN

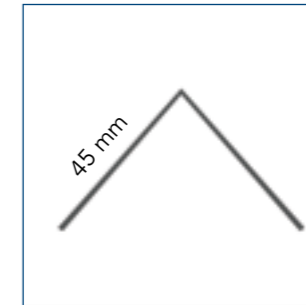

NOM NAAM	EP. D'ENDUIT PLEISTERDIKTE	STOCK STOCK	NR ARTICLE ARTIKEL NR	DIMENSION AFMETING	PIÈCES/EMB. STUKS/VERP.	ML/EMB. LM/VERP.	EMB./PAL. VERP./PAL.
<b>CORNER BEAD PVC ECO</b>	3 mm		8403070270	2,70 m	70	189,00	40

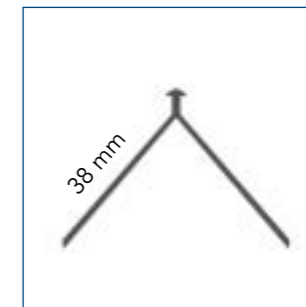

NOM NAAM	EP. D'ENDUIT PLEISTERDIKTE	STOCK STOCK	NR ARTICLE ARTIKEL NR	DIMENSION AFMETING	PIÈCES/EMB. STUKS/VERP.	ML/EMB. LM/VERP.	EMB./PAL. VERP./PAL.
<b>CORNER BEAD PVC</b>	4 mm	S	8004025250	2,50 m	25	62,50	40

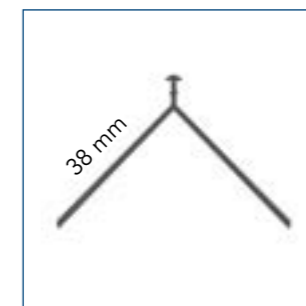
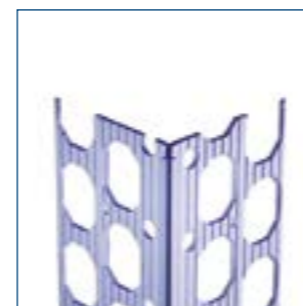

NOM NAAM	EP. D'ENDUIT PLEISTERDIKTE	STOCK STOCK	NR ARTICLE ARTIKEL NR	DIMENSION AFMETING	PIÈCES/EMB. STUKS/VERP.	ML/EMB. LM/VERP.	EMB./PAL. VERP./PAL.
<b>CORNER BEAD PVC</b>	6 mm	S	8006025250	2,50 m	25	62,50	40

## PROFILÉS D'ANGLE HOEKPROFIELEN

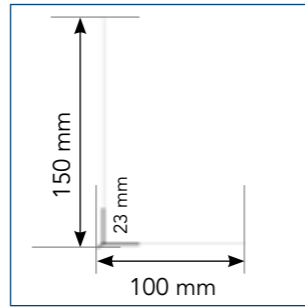

NOM NAAM	EP. D'ENDUIT PLEISTERDIKTE	STOCK STOCK	NR ARTICLE ARTIKEL NR	DIMENSION AFMETING	PIÈCES/EMB. STUKS/VERP.	ML/EMB. LM/VERP.	EMB./PAL. VERP/PAL.	
<b>PER PVC MAXI GWS</b>	<b>8114</b>	6 mm		8114025250	2,50 m	25	62,50	40

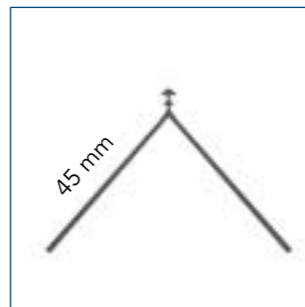
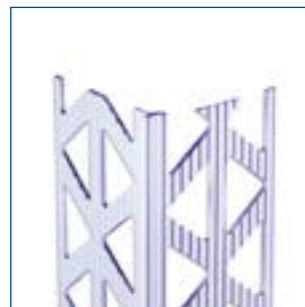

NOM NAAM	EP. D'ENDUIT PLEISTERDIKTE	STOCK STOCK	NR ARTICLE ARTIKEL NR	DIMENSION AFMETING	PIÈCES/EMB. STUKS/VERP.	ML/EMB. LM/VERP.	EMB./PAL. VERP/PAL.	
<b>CORNER BEAD PVC ECO</b>	<b>8406</b>	6 mm		8406025270	2,70 m	25	67,50	40

## PROFILÉS D'ANGLE AVEC GOUTTE D'EAU HOEKPROFIELEN MET DRUPPELSTOP

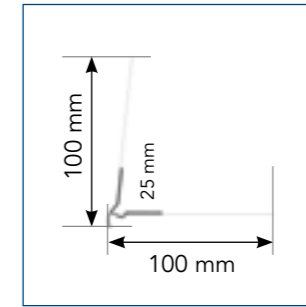
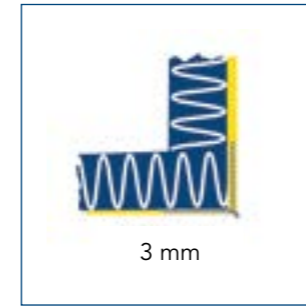

NOM NAAM	EP. D'ENDUIT PLEISTERDIKTE	STOCK STOCK	NR ARTICLE ARTIKEL NR	DIMENSION AFMETING	PIÈCES/EMB. STUKS/VERP.	ML/EMB. LM/VERP.	EMB./PAL. VERP/PAL.	
<b>CORNER REND PVC GWS</b>	<b>8124</b>	3 mm	S	8124025250	2,50 m	25	62,50	40

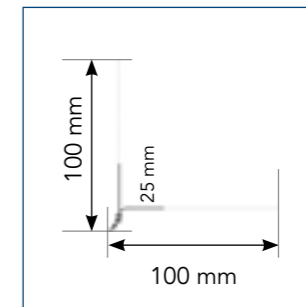
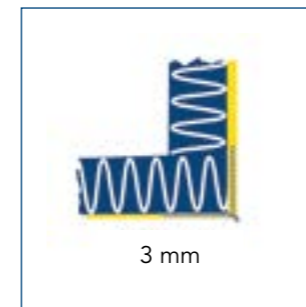

NOM NAAM	EP. D'ENDUIT PLEISTERDIKTE	STOCK STOCK	NR ARTICLE ARTIKEL NR	DIMENSION AFMETING	PIÈCES/EMB. STUKS/VERP.	ML/EMB. LM/VERP.	EMB./PAL. VERP/PAL.	
<b>CORNER REND PVC GWS ECO</b>	<b>8424</b>	3 mm		8424050250	2,50 m	50	125,00	36

## PROFILÉS D'ARRÊT STOP- & AFWERKPROFIELEN

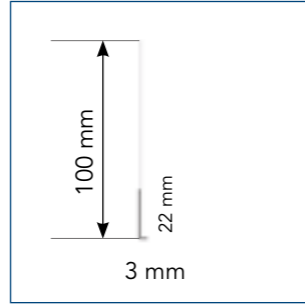
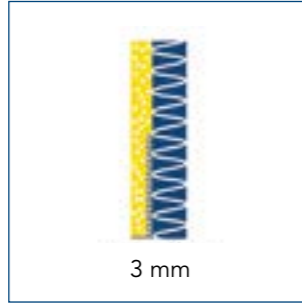

NOM NAAM	EP. D'ENDUIT PLEISTERDIKTE	STOCK STOCK	NR ARTICLE ARTIKEL NR	DIMENSION AFMETING	PIÈCES/EMB. STUKS/VERP.	ML/EMB. LM/VERP.	EMB./PAL. VERP./PAL.
<b>STOP PVC GWS PRO</b> 8703	3 mm	S	8703025250	2,50 m	25	62,50	

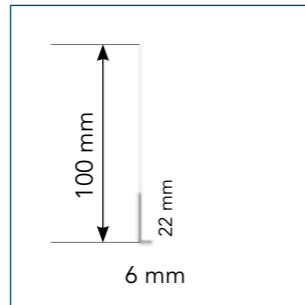
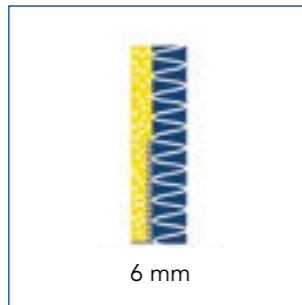
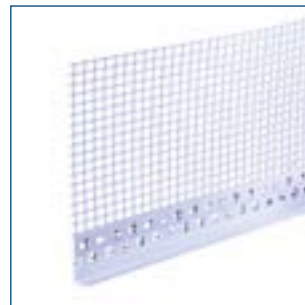

NOM NAAM	EP. D'ENDUIT PLEISTERDIKTE	STOCK STOCK	NR ARTICLE ARTIKEL NR	DIMENSION AFMETING	PIÈCES/EMB. STUKS/VERP.	ML/EMB. LM/VERP.	EMB./PAL. VERP./PAL.
<b>STOP PVC GWS PRO</b> 8704	6 mm		8704025250	2,50 m	25	62,50	

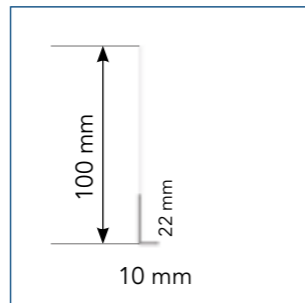
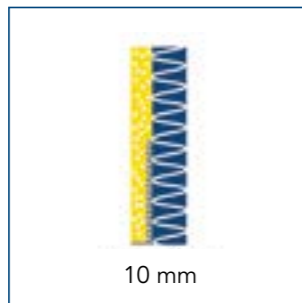
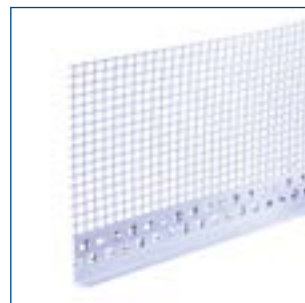

NOM NAAM	EP. D'ENDUIT PLEISTERDIKTE	STOCK STOCK	NR ARTICLE ARTIKEL NR	DIMENSION AFMETING	PIÈCES/EMB. STUKS/VERP.	ML/EMB. LM/VERP.	EMB./PAL. VERP./PAL.
<b>STOP PVC GWS PRO</b> 8705	10 mm		8705025250	2,50 m	25	62,50	

## PROFILÉS D'ARRÊT STOP- & AFWERKPROFIELEN

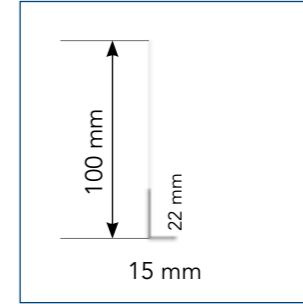
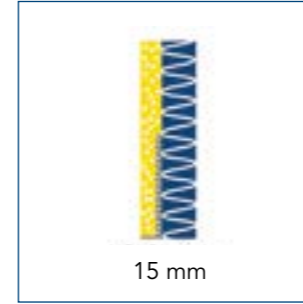
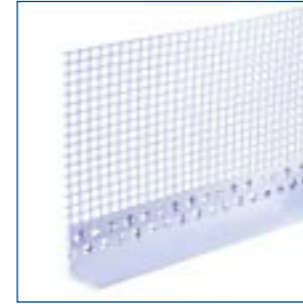

NOM NAAM	EP. D'ENDUIT PLEISTERDIKTE	STOCK STOCK	NR ARTICLE ARTIKEL NR	DIMENSION AFMETING	PIÈCES/EMB. STUKS/VERP.	ML/EMB. LM/VERP.	EMB./PAL. VERP./PAL.
<b>STOP PVC GWS PRO</b> 8706	15 mm		8706025250	2,50 m	25	62,50	

## PROFILÉS DE DILATATION UITZETTINGSPROFIELEN

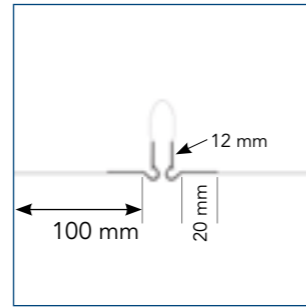
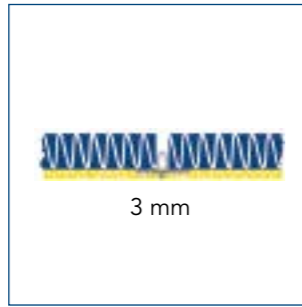

NOM NAAM	EP. D'ENDUIT PLEISTERDIKTE	STOCK STOCK	NR ARTICLE ARTIKEL NR	DIMENSION AFMETING	PIÈCES/EMB. STUKS/VERP.	ML/EMB. LM/VERP.	EMB./PAL. VERP./PAL.	
<b>DILAT PVC GWS "V"</b>	<b>8034</b>	3 mm	S	8034025250	2,50 m	25	62,50	16

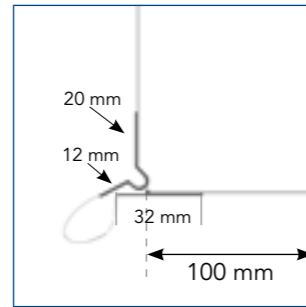

NOM NAAM	EP. D'ENDUIT PLEISTERDIKTE	STOCK STOCK	NR ARTICLE ARTIKEL NR	DIMENSION AFMETING	PIÈCES/EMB. STUKS/VERP.	ML/EMB. LM/VERP.	EMB./PAL. VERP./PAL.	
<b>DILAT PVC GWS "E"</b>	<b>8035</b>	3 mm	S	8035025250	2,50 m	25	62,50	16

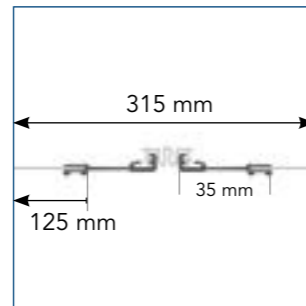
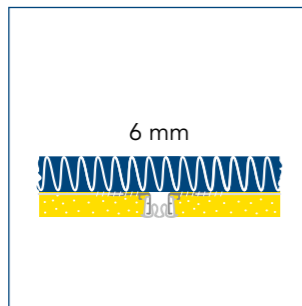
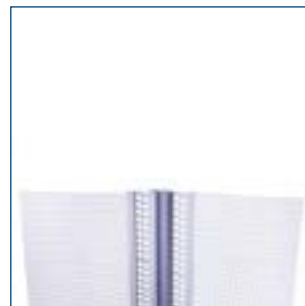

NOM NAAM	EP. D'ENDUIT PLEISTERDIKTE	STOCK STOCK	NR ARTICLE ARTIKEL NR	DIMENSION AFMETING	PIÈCES/EMB. STUKS/VERP.	ML/EMB. LM/VERP.	EMB./PAL. VERP./PAL.	
<b>DILAT PVC GWS</b>	<b>8030</b>	6 mm		8030010300	3,00 m	10	30,00	32
<b>DILAT PVC GWS COLOR (beige)</b>	<b>9004</b>	6 mm		9004010260	2,60 m	10	26,00	32
<b>DILAT PVC GWS COLOR (gris/grijs)</b>	<b>9005</b>	6 mm		9005010260	2,60 m	10	26,00	32

## PROFILÉS DE DILATATION UITZETTINGSPROFIELEN

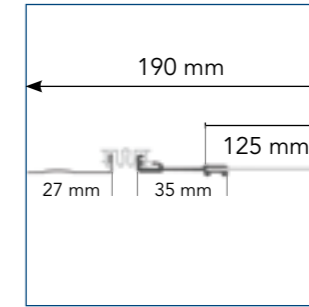
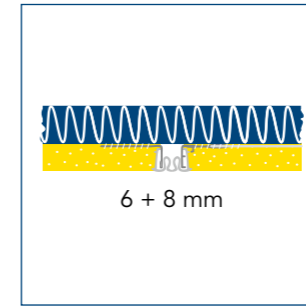

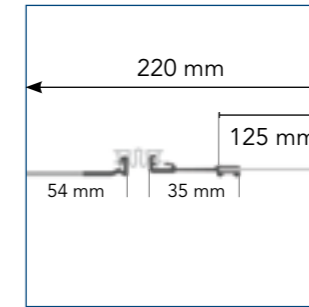
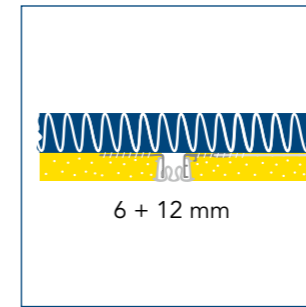

NOM NAAM	EP. D'ENDUIT PLEISTERDIKTE	STOCK STOCK	NR ARTICLE ARTIKEL NR	DIMENSION AFMETING	PIÈCES/EMB. STUKS/VERP.	ML/EMB. LM/VERP.	EMB./PAL. VERP./PAL.	
<b>DILAT PVC INOX MINI</b>	<b>2406</b>	6 + 8 mm		2406005300	3,00 m	5	15,00	64

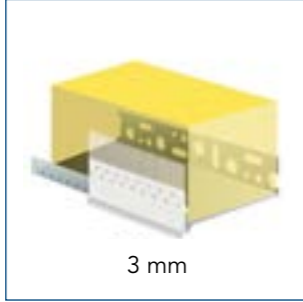
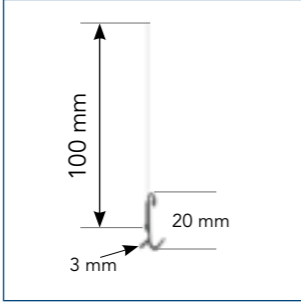

NOM NAAM	EP. D'ENDUIT PLEISTERDIKTE	STOCK STOCK	NR ARTICLE ARTIKEL NR	DIMENSION AFMETING	PIÈCES/EMB. STUKS/VERP.	ML/EMB. LM/VERP.	EMB./PAL. VERP./PAL.	
<b>DILAT PVC INOX MAXI</b>	<b>2407</b>	6 + 12 mm		2407005300	3,00 m	5	15,00	64

## PROFILÉS D'ARRÊT POUR PROFILÉS DE DÉPART STOPPROFIELEN VOOR SOKKELPROFIELEN

								
NOM NAAM	EP. D'ENDUIT PLEISTERDIKTE	STOCK STOCK	NR ARTICLE ARTIKEL NR	DIMENSION AFMETING	PIÈCES/EMB. STUKS/VERP.	ML/EMB. LM/VERP.	EMB./PAL. VERP./PAL.	
<b>STOP ISO GWS</b>	<b>8233</b>	3 mm	S	8233025250	2,50 m	25	62,50	24

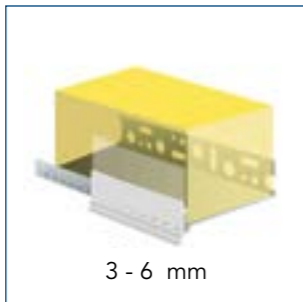
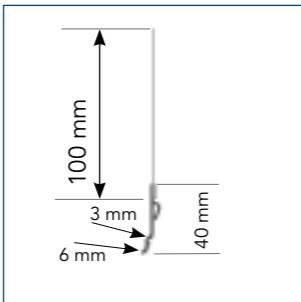
								
NOM NAAM	EP. D'ENDUIT PLEISTERDIKTE	STOCK STOCK	NR ARTICLE ARTIKEL NR	DIMENSION AFMETING	PIÈCES/EMB. STUKS/VERP.	ML/EMB. LM/VERP.	EMB./PAL. VERP./PAL.	
<b>STOP ISO GWS DUO PRO</b>	<b>8235</b>	3 / 6 mm		8235050250	2,50 m	50	125,00	26

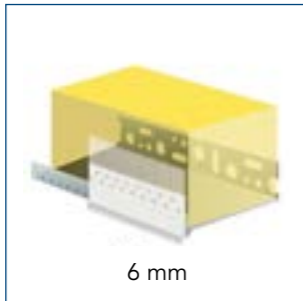
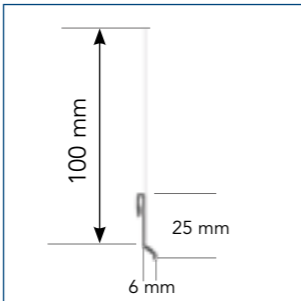
								
NOM NAAM	EP. D'ENDUIT PLEISTERDIKTE	STOCK STOCK	NR ARTICLE ARTIKEL NR	DIMENSION AFMETING	PIÈCES/EMB. STUKS/VERP.	ML/EMB. LM/VERP.	EMB./PAL. VERP./PAL.	
<b>STOP ISO GWS</b>	<b>8234</b>	6 mm	S	8234025250	2,50 m	25	62,50	24

## PROFILÉS D'ARRÊT POUR PROFILÉS DE DÉPART STOPPROFIELEN VOOR SOKKELPROFIELEN

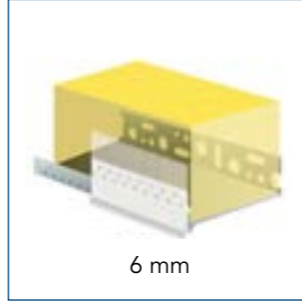
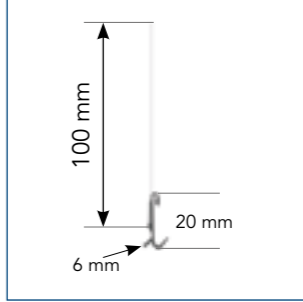
								
NOM NAAM	EP. D'ENDUIT PLEISTERDIKTE	STOCK STOCK	NR ARTICLE ARTIKEL NR	DIMENSION AFMETING	PIÈCES/EMB. STUKS/VERP.	ML/EMB. LM/VERP.	EMB./PAL. VERP./PAL.	
<b>STOP ISO GWS</b>	<b>8236</b>	6 mm	S	8236030250	2,50 m	30	75,00	40

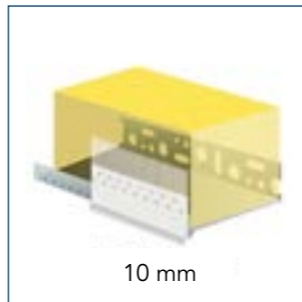
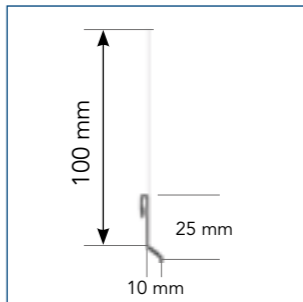
								
NOM NAAM	EP. D'ENDUIT PLEISTERDIKTE	STOCK STOCK	NR ARTICLE ARTIKEL NR	DIMENSION AFMETING	PIÈCES/EMB. STUKS/VERP.	ML/EMB. LM/VERP.	EMB./PAL. VERP./PAL.	
<b>STOP ISO GWS</b>	<b>8231</b>	10 mm		8231025250	2,50 m	25	62,50	24

## PROFILÉS DE DÉPART SOKKELPROFIELEN

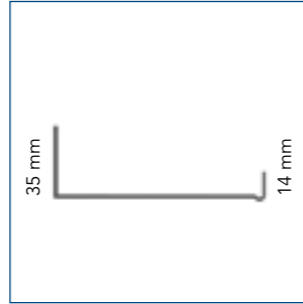
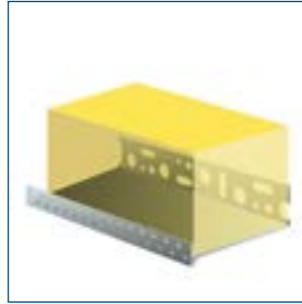

NOM NAAM	EP. ISOLATION ISOLATIEDIKTE	STOCK STOCK	NR ARTICLE ARTIKEL NR	DIMENSION AFMETING	PIÈCES/EMB. STUKS/VERP.	ML/EMB. LM/VERP.	EMB./PAL. VERP/PAL.	
ALUSOCLE (1 mm)	0336	30 mm	S	0336010250	2,50 m	10	25,00	121
	0337	40 mm	S	0337010250	2,50 m	10	25,00	108
	0338	50 mm	S	0338010250	2,50 m	10	25,00	77
	0339	60 mm	S	0339010250	2,50 m	10	25,00	86
	0340	70 mm	S	0340010250	2,50 m	10	25,00	90
	0341	80 mm	S	0341010250	2,50 m	10	25,00	65
	0342	90 mm	S	0342010250	2,50 m	10	25,00	60
	3394	100 mm	S	3394010250	2,50 m	10	25,00	54
	3351	110 mm	S	3351010250	2,50 m	10	25,00	40
	3395	120 mm	S	3395010250	2,50 m	10	25,00	45
	3352	130 mm	S	3352010250	2,50 m	10	25,00	40
	3396	140 mm	S	3396010250	2,50 m	10	25,00	40
	3353	150 mm	S	3353010250	2,50 m	10	25,00	31
	3397	160 mm	S	3397010250	2,50 m	10	25,00	36
	3354	170 mm		3354010250	2,50 m	10	25,00	40
	3398	180 mm	S	3398010250	2,50 m	10	25,00	31
	3355	190 mm	S	3355010250	2,50 m	10	25,00	40
	3399	200 mm	S	3399010250	2,50 m	10	25,00	30
	3356	210 mm		3356010250	2,50 m	10	25,00	40
	3369	220 mm	S	3369010250	2,50 m	10	25,00	40
3357	230 mm		3357010250	2,50 m	10	25,00	40	
3370	240 mm	S	3370010250	2,50 m	10	25,00	40	
3358	250 mm		3358010250	2,50 m	10	25,00	40	

## PROFILÉS DE DÉPART SOKKELPROFIELEN

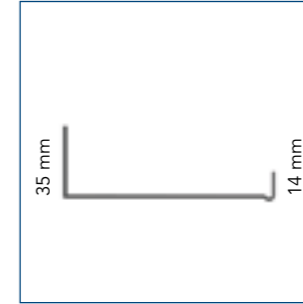
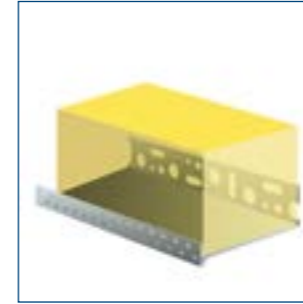

NOM NAAM	EP. ISOLATION ISOLATIEDIKTE	STOCK STOCK	NR ARTICLE ARTIKEL NR	DIMENSION AFMETING	PIÈCES/EMB. STUKS/VERP.	ML/EMB. LM/VERP.	EMB./PAL. VERP/PAL.	
ALUSOCLE (1,2 mm)	0394	100 mm		0394010250	2,50 m	10	25,00	54
	0351	110 mm		0351010250	2,50 m	10	25,00	40
	0395	120 mm		0395010250	2,50 m	10	25,00	45
	0352	130 mm		0352010250	2,50 m	10	25,00	40
	0396	140 mm		0396010250	2,50 m	10	25,00	40
	0353	150 mm		0353010250	2,50 m	10	25,00	31
	0397	160 mm		0397010250	2,50 m	10	25,00	36
	0354	170 mm		0354010250	2,50 m	10	25,00	40
	0398	180 mm		0398010250	2,50 m	10	25,00	31
	0355	190 mm		0355010250	2,50 m	10	25,00	40
	0399	200 mm		0399010250	2,50 m	10	25,00	30
	0356	210 mm		0356010250	2,50 m	10	25,00	40
	0369	220 mm		0369010250	2,50 m	10	25,00	40
	0357	230 mm		0357010250	2,50 m	10	25,00	40
	0370	240 mm		0370010250	2,50 m	10	25,00	40
	0358	250 mm		0358010250	2,50 m	10	25,00	40



## PROFILÉS DE DÉPART SOKKELPROFIELEN

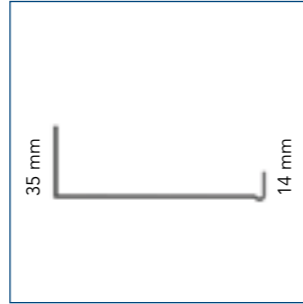
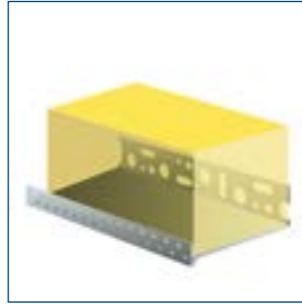

NOM NAAM		EP. ISOLATION ISOLATIEDIKTE	STOCK STOCK	NR ARTICLE ARTIKEL NR	DIMENSION AFMETING	PIÈCES/EMB. STUKS/VERP.	ML/EMB. LM/VERP.	EMB./PAL. VERP./PAL.
INOSOCLE	0471	30 mm		0471010250	2,50 m	10	25,00	40
	0472	40 mm		0472010250	2,50 m	10	25,00	40
	0473	50 mm		0473010250	2,50 m	10	25,00	40
	0474	60 mm		0474010250	2,50 m	10	25,00	40
	0475	70 mm		0475010250	2,50 m	10	25,00	40
	0476	80 mm		0476010250	2,50 m	10	25,00	40
	0478	100 mm		0478010250	2,50 m	10	25,00	40
	0480	120 mm		0480004250	2,50 m	4	10,00	40
	0482	140 mm		0482004250	2,50 m	4	10,00	40
	0484	160 mm		0484004250	2,50 m	4	10,00	40
	0486	180 mm		0486004250	2,50 m	4	10,00	40

## PROFILÉS DE DÉPART SOKKELPROFIELEN

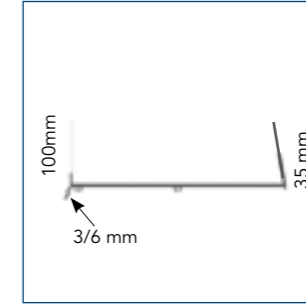
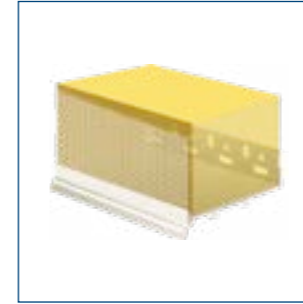
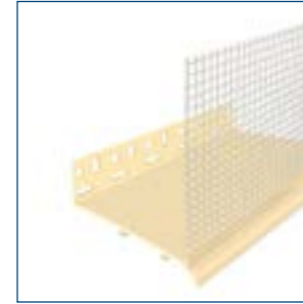

NOM NAAM		EP. ISOLATION ISOLATIEDIKTE	STOCK STOCK	NR ARTICLE ARTIKEL NR	DIMENSION AFMETING	PIÈCES/EMB. STUKS/VERP.	ML/EMB. LM/VERP.	EMB./PAL. VERP./PAL.
SOCLE PVC GWS PRO	8441	80 mm	S	8441010200	2,00 m	10	20,00	144
	8443	100 mm	S	8443010200	2,00 m	10	20,00	128
	8495	120 mm	S	8495010200	2,00 m	10	20,00	98
	8496	140 mm	S	8496010200	2,00 m	10	20,00	86
	8453	150 mm	S	8453010200	2,00 m	10	20,00	79
	8497	160 mm	S	8497010200	2,00 m	10	20,00	72
	8498	180 mm		8498010200	2,00 m	10	20,00	64
	8499	200 mm		8499010200	2,00 m	10	20,00	50

## PROFILÉS DE COURONNEMENT BEDEKKINGSPROFIELEN

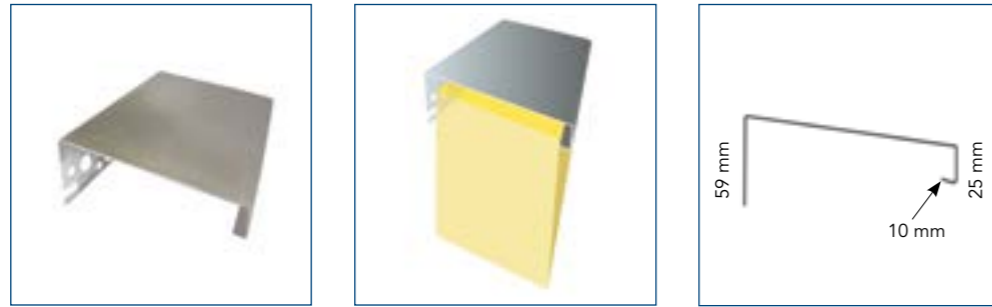

NOM NAAM	LARGEUR PROFILÉ PROFIEL BREEDETE	EP. ISOLANT ISOLATIE-DIKTE	STOCK STOCK	N° ARTICLE ARTIKEL NR	DIMENSION AFMETING	PIÈCES/EMB. STUKS/VERP.	ML/EMB. LM/VERP.	EMB./PAL. VERP./PAL.	
ISOCOVER ALU	0389	70 mm	40 mm	S	0389010250	2,50 m	10	25,00	40
	0390	80 mm	50 mm	S	0390010250	2,50 m	10	25,00	40
	0317	90 mm	60 mm		0317010250	2,50 m	10	25,00	40
	0391	100 mm	70 mm	S	0391010250	2,50 m	10	25,00	40
	0318	110 mm	80 mm		0318010250	2,50 m	10	25,00	40
	0392	120 mm	90 mm	S	0392010250	2,50 m	10	25,00	40
	0319	130 mm	100 mm		0319010250	2,50 m	10	25,00	40
	0393	140 mm	110 mm	S	0393010250	2,50 m	10	25,00	40
	0320	150 mm	120 mm	S	0320010250	2,50 m	10	25,00	40
	0321	160 mm	130 mm		0321010250	2,50 m	10	25,00	40
	0322	170 mm	140 mm		0322010250	2,50 m	10	25,00	40
	0323	180 mm	150 mm		0323010250	2,50 m	10	25,00	40
	0324	190 mm	160 mm		0324010250	2,50 m	10	25,00	40
	0325	200 mm	170 mm		0325010250	2,50 m	10	25,00	40

## PROFILÉS D'ARRÊT LATÉRAL VERTICALE PROFIELEN

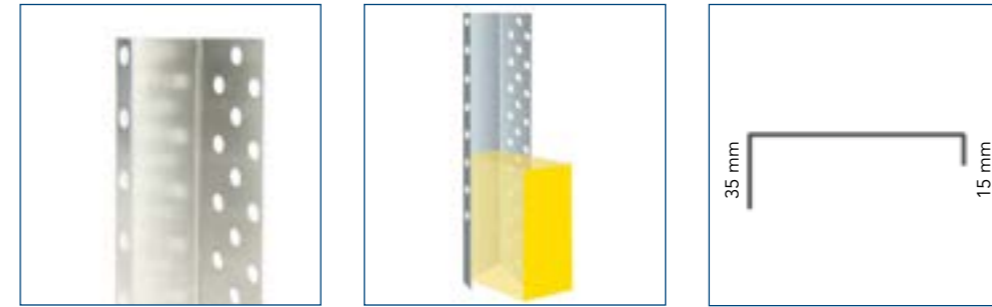

NOM NAAM	EP. ISOLATION ISOLATIEDIKTE	STOCK STOCK	NR ARTICLE ARTIKEL NR	DIMENSION AFMETING	PIÈCES/EMB. STUKS/VERP.	ML/EMB. LM/VERP.	EMB./PAL. VERP./PAL.	
ISOBORD ALU	0360	30 mm	S	0360010250	2,50 m	10	25,00	40
	0361	40 mm	S	0361010250	2,50 m	10	25,00	40
	0362	50 mm	S	0362010250	2,50 m	10	25,00	40
	0363	60 mm	S	0363010250	2,50 m	10	25,00	40
	0364	70 mm	S	0364010250	2,50 m	10	25,00	40
	0365	80 mm	S	0365010250	2,50 m	10	25,00	40
	0298	90 mm		0298010250	2,50 m	10	25,00	40
	0366	100 mm	S	0366010250	2,50 m	10	25,00	40
	0299	110 mm	S	0299010250	2,50 m	10	25,00	40
	0367	120 mm	S	0367010250	2,50 m	10	25,00	40
	0300	130 mm		0300010250	2,50 m	10	25,00	40
	0368	140 mm	S	0368010250	2,50 m	10	25,00	40
	0301	150 mm	S	0301010250	2,50 m	10	25,00	40
	0302	160 mm		0302010250	2,50 m	10	25,00	40
	0303	170 mm		0303010250	2,50 m	10	25,00	40
	0304	180 mm		0304010250	2,50 m	10	25,00	40
	0305	190 mm		0305010250	2,50 m	10	25,00	40
	0306	200 mm	S	0306010250	2,50 m	10	25,00	40
	0307	210 mm		0307010250	2,50 m	10	25,00	40
	0308	220 mm		0308010250	2,50 m	10	25,00	40
	0309	230 mm		0309010250	2,50 m	10	25,00	40
0310	240 mm		0310010250	2,50 m	10	25,00	40	
0311	250 mm		0311010250	2,50 m	10	25,00	40	

## PROFILÉS DE VENTILATION VENTILATIE PROFIELEN

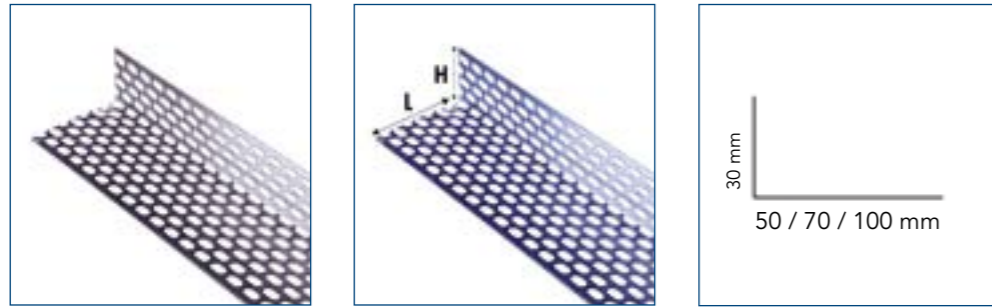

NOM NAAM	LARGEUR PROFILÉ PROFIEL BREEDETE	STOCK STOCK	NR ARTICLE ARTIKEL NR	DIMENSION AFMETING	PIÈCES/EMB. STUKS/VERP.	ML/EMB. LM/VERP.	EMB./PAL. VERP/PAL.
AERO PROFIL	0280	30 X 50 mm	0280020250	2,50 m	20	50,00	50
	0281	30 X 70 mm	0281020250	2,50 m	20	50,00	50
	0282	30 X 100 mm	0282020250	2,50 m	20	50,00	50

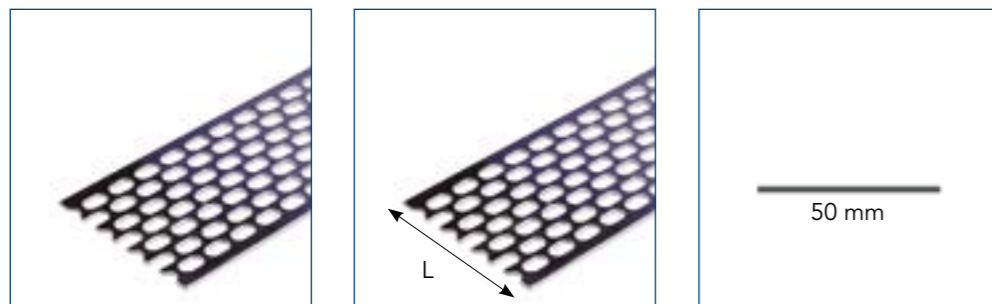

NOM NAAM	LARGEUR PROFILÉ PROFIEL BREEDETE	STOCK STOCK	NR ARTICLE ARTIKEL NR	DIMENSION AFMETING	PIÈCES/EMB. STUKS/VERP.	ML/EMB. LM/VERP.	EMB./PAL. VERP/PAL.
AERO BAND	0283	50 mm	0283002050	60 X 0,05 m	2		46

## PROFILÉS PVC POUR PORTES & FENÊTRES AFWERKPROFIELEN VOOR DEUREN & RAMEN

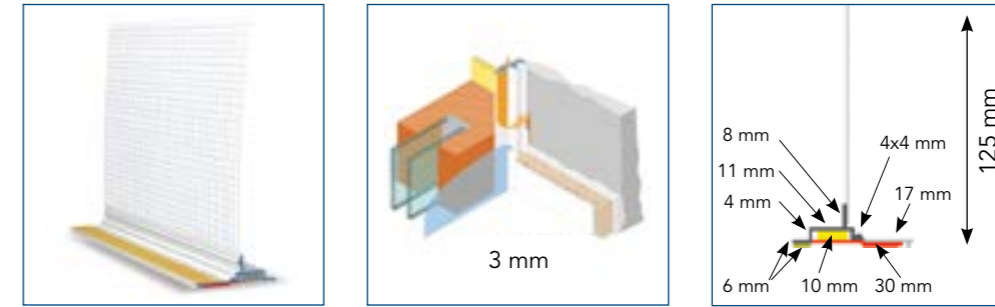

NOM NAAM	EP. D'ENDUIT PLEISTERDIKTE	STOCK STOCK	NR ARTICLE ARTIKEL NR	DIMENSION AFMETING	PIÈCES/EMB. STUKS/VERP.	ML/EMB. LM/VERP.	EMB./PAL. VERP/PAL.
APU W38 / PUR-FIX PRO S	8299	3 mm	8299025240	2,40 m	25	60,00	40

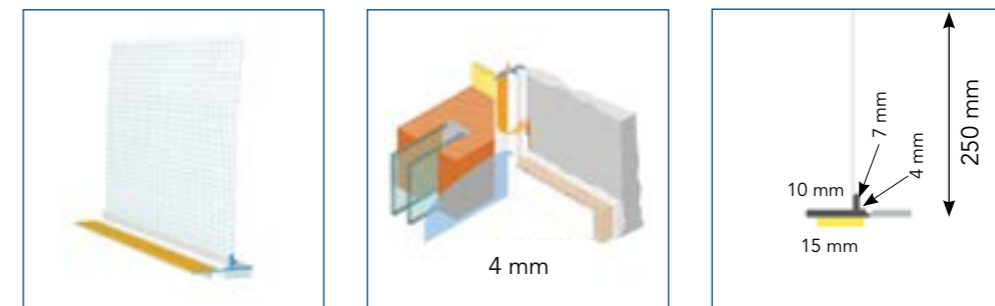

NOM NAAM	EP. D'ENDUIT PLEISTERDIKTE	STOCK STOCK	NR ARTICLE ARTIKEL NR	DIMENSION AFMETING	PIÈCES/EMB. STUKS/VERP.	ML/EMB. LM/VERP.	EMB./PAL. VERP/PAL.
APU W23 / STANDARD-UV	8104	4 mm	8104025140	1,40 m	25	35,00	50
	8104	4 mm	8104025240	2,40 m	25	60,00	50

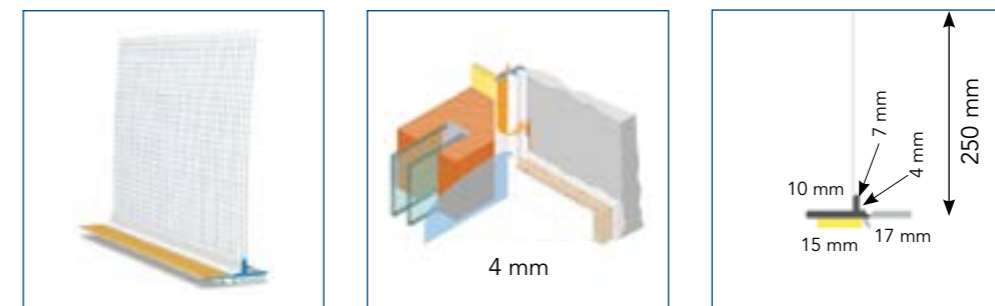

NOM NAAM	EP. D'ENDUIT PLEISTERDIKTE	STOCK STOCK	NR ARTICLE ARTIKEL NR	DIMENSION AFMETING	PIÈCES/EMB. STUKS/VERP.	ML/EMB. LM/VERP.	EMB./PAL. VERP/PAL.
APU W23+ / STANDARD-PLUS	8804	4 mm	8804025140	1,40 m	25	35,00	30
	8804	4 mm	8804025240	2,40 m	25	60,00	30

## PROFILÉS PVC POUR PORTES & FENÊTRES AFWERKPROFIELEN VOOR DEUREN & RAMEN

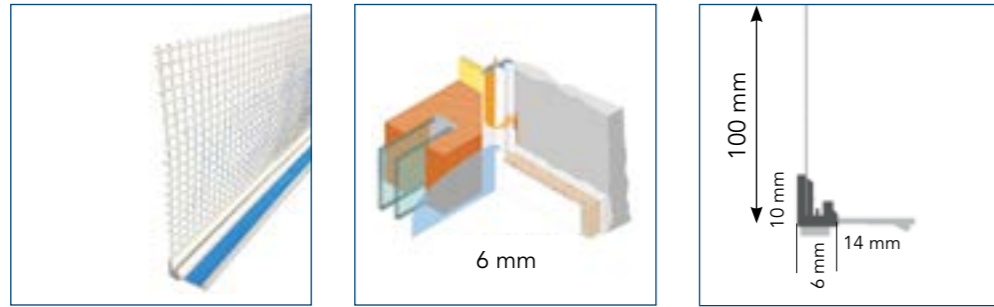

NOM NAAM	EP. D'ENDUIT PLEISTERDIKTE	STOCK STOCK	NR ARTICLE ARTIKEL NR	DIMENSION AFMETING	PIÈCES/EMB. STUKS/VERP.	ML/EMB. LM/VERP.	EMB./PAL. VERP/PAL.	
<b>PROFI INTER GWS PRO</b>	<b>8167</b>	6 mm		8167050240	2,40 m	50	120,00	33

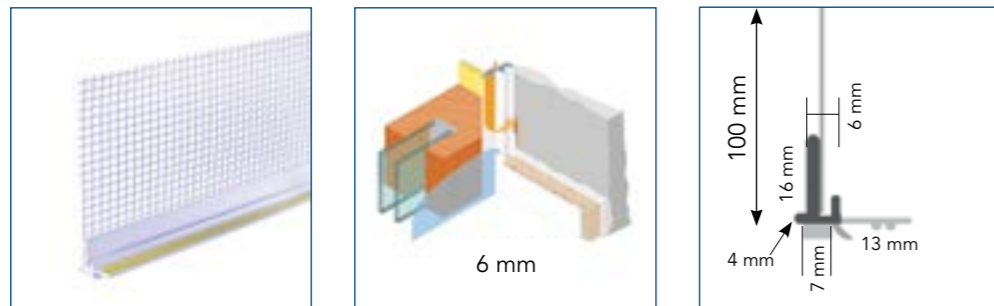

NOM NAAM	EP. D'ENDUIT PLEISTERDIKTE	STOCK STOCK	NR ARTICLE ARTIKEL NR	DIMENSION AFMETING	PIÈCES/EMB. STUKS/VERP.	ML/EMB. LM/VERP.	EMB./PAL. VERP/PAL.	
<b>PROFI INTER GWS LIPPE</b>	<b>8808</b>	6 mm	S	8808025240	2,40 m	25	60,00	24
<b>PROFI INTER GWS LIPPE COLOR (gris / grijs)</b>	<b>9808</b>	6 mm		9808025240	2,40 m	25	60,00	24

\* Autres couleurs sur demande / Andere kleuren op aanvraag

## PROFILÉS PVC POUR PORTES & FENÊTRES AFWERKPROFIELEN VOOR DEUREN & RAMEN

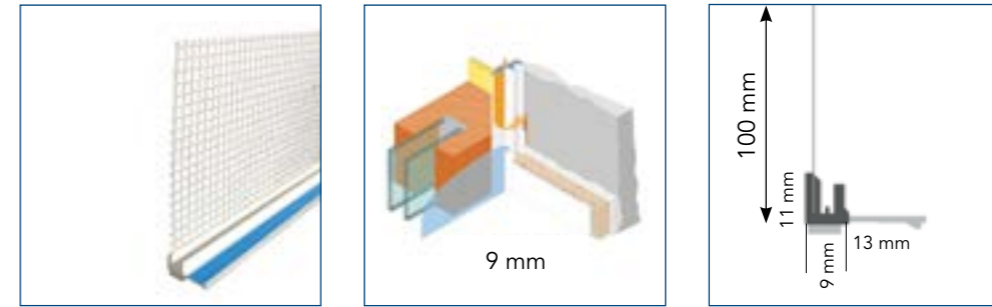

NOM NAAM	EP. D'ENDUIT PLEISTERDIKTE	STOCK STOCK	NR ARTICLE ARTIKEL NR	DIMENSION AFMETING	PIÈCES/EMB. STUKS/VERP.	ML/EMB. LM/VERP.	EMB./PAL. VERP/PAL.	
<b>PROFI MINI GWS PRO</b>	<b>8168</b>	9 mm		8168030240	2,40 m	30	72,00	33

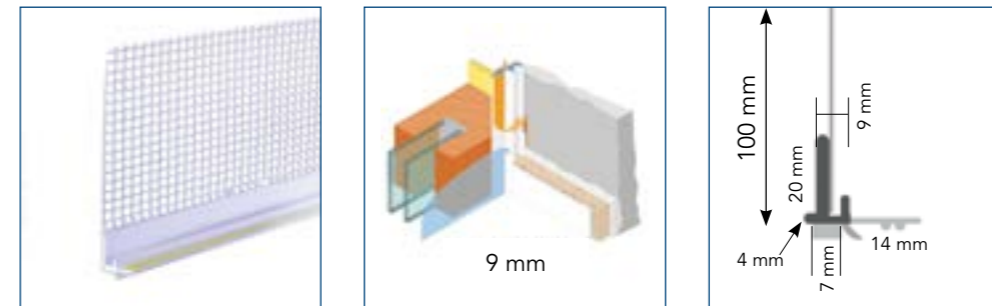

NOM NAAM	EP. D'ENDUIT PLEISTERDIKTE	STOCK STOCK	NR ARTICLE ARTIKEL NR	DIMENSION AFMETING	PIÈCES/EMB. STUKS/VERP.	ML/EMB. LM/VERP.	EMB./PAL. VERP/PAL.	
<b>PROFI MINI GWS LIPPE</b>	<b>8809</b>	9 mm		8809025240	2,40 m	25	60,00	48
<b>PROFI MINI GWS LIPPE COLOR (gris / grijs)</b>	<b>9809</b>	9 mm		9809025240	2,40 m	25	60,00	48

\* Autres couleurs sur demande / Andere kleuren op aanvraag

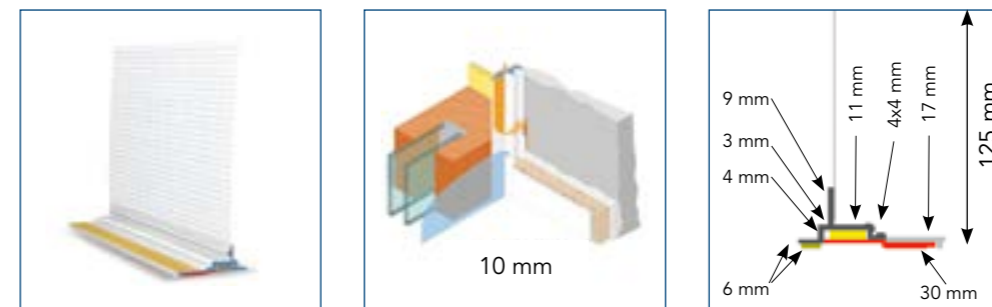

NOM NAAM	EP. D'ENDUIT PLEISTERDIKTE	STOCK STOCK	NR ARTICLE ARTIKEL NR	DIMENSION AFMETING	PIÈCES/EMB. STUKS/VERP.	ML/EMB. LM/VERP.	EMB./PAL. VERP/PAL.	
<b>APU W38 / PUR-FIX PRO K</b>	<b>8289</b>	10 mm		8289025240	2,40 m	25	60,00	40

## CHEVILLES D'ISOLATION ISOLATIE PLUGGEN

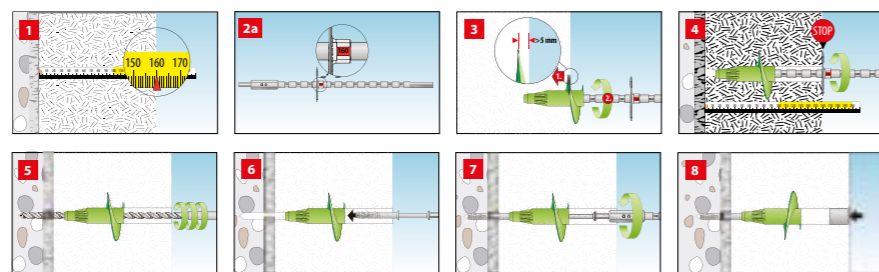

NOM NAAM	STOCK STOCK	N° ARTICLE ARTIKEL NR	DIMENSION AFMETING	PCES/EMB. STUKS/VERP.	EMB./PAL. VERP./PAL.
ISOFIX GECKO	1601	1601150100	8 X 100 mm	150	



NOM NAAM	STOCK STOCK	N° ARTICLE ARTIKEL NR	DIMENSION AFMETING	PCES/EMB. STUKS/VERP.	EMB./PAL. VERP./PAL.	
ISOFIX DSH K (clou pvc/pvcnagel)	1602	S	1602250090	10 X 90 mm	250	48
	1603	S	1603250110	10 X 110 mm	250	48
	1604	S	1604250130	10 X 130 mm	250	40
	1605		1605250140	10 X 140 mm	250	40
	1606	S	1606250150	10 X 150 mm	250	40
	1607		1607250160	10 X 160 mm	250	40
	1608	S	1608250170	10 X 170 mm	250	32
	1610	S	1610250190	10 X 190 mm	250	32

## CHEVILLES D'ISOLATION ISOLATIE PLUGGEN



NOM NAAM	STOCK STOCK	N° ARTICLE ARTIKEL NR	DIMENSION AFMETING	PCES/EMB. STUKS/VERP.	EMB./PAL. VERP./PAL.	
ISOFIX MAXI TSD-V KN (clou pvc/pvcnagel)	1633		1633200100	8 X 100 mm	200	48
	1634		1634200120	8 X 120 mm	200	48
	1635		1635200140	8 X 140 mm	200	40
	1636		1636200160	8 X 160 mm	200	40
	1637		1637200180	8 X 180 mm	200	32
	1638	S	1638200200	8 X 200 mm	200	32
	1639	S	1639100220	8 X 220 mm	100	48
	1640	S	1640100240	8 X 240 mm	100	40
	1641	S	1641100260	8 X 260 mm	100	40
	1642	S	1642100280	8 X 280 mm	100	32
	1643		1643100300	8 X 300 mm	100	32

## CHEVILLES D'ISOLATION ISOLATIE PLUGGEN

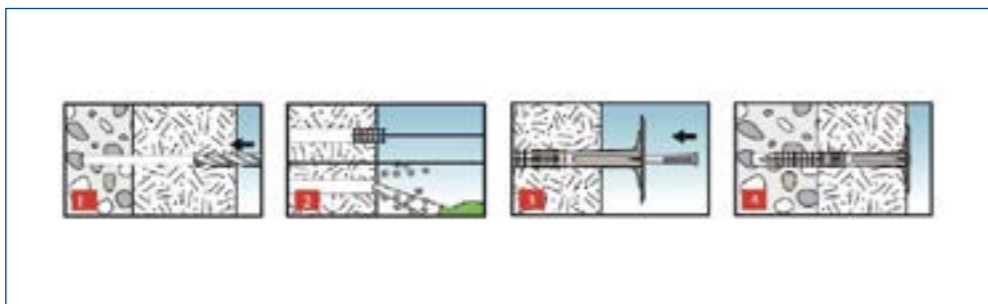

NOM NAAM	STOCK STOCK	N° ARTICLE ARTIKEL NR	DIMENSION AFMETING	PCES/EMB. STUKS/VERP.	EMB./PAL. VERP./PAL.
ISOFIX MAXI TSD (clou métal/metaalnagel)	1621	1621200080	8 X 80 mm	200	48
	1622	1622200100	8 X 100 mm	200	48
	1623	1623200120	8 X 120 mm	200	48
	1624	1624200140	8 X 140 mm	200	40
	1625	1625200160	8 X 160 mm	200	40
	1626	1626200180	8 X 180 mm	200	32
	1627	1627200200	8 X 200 mm	200	32
	1628	1628100220	8 X 220 mm	100	48
	1629	1629100240	8 X 240 mm	100	40
	1630	1630100260	8 X 260 mm	100	40
	1631	1631100280	8 X 280 mm	100	32
	1632	1632100300	8 X 300 mm	100	32

## FIBRE DE VERRE GLASVEZEL

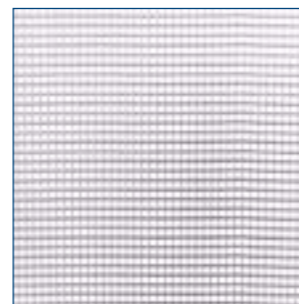

NOM NAAM	STOCK STOCK	NR ARTICLE ARTIKEL NR	DIMENSION AFMETING	PIÈCES/EMB. STUKS/VERP.	EMB./PAL. VERP./PAL.
ISOTEX 4X4 (160 gr/m²) - certifié Q-Bat gecertificeerd - (blanc/wit)	4165	4165001050	50 m X 100 cm	1	33
	4167	4167001050	50 m X 110 cm	1	33
ISOTEX 4X4 (160 gr/m²) - certifié/gecertificeerd - (orange/oranje)	4166	4166001050	50 m X 100 cm	1	33

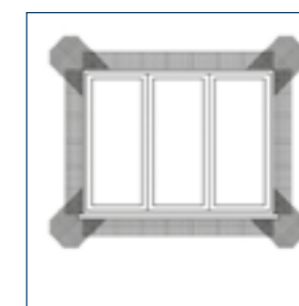

NOM NAAM	STOCK STOCK	NR ARTICLE ARTIKEL NR	DIMENSION AFMETING	PIÈCES/EMB. STUKS/VERP.	EMB./PAL. VERP./PAL.
MOUCHOIR (à plat/vlak)	4170	4170100050	33 X 50 cm	100	60
MOUCHOIR (coin/hoek)	4171	4171025010	10 cm	25	
	4172	4172025020	20 cm	25	

## ACCESSOIRES TOEBEHOREN



NOM NAAM	STOCK STOCK	NR ARTICLE ARTIKEL NR	DIMENSION AFMETING	PIÈCES/EMB. STUKS/VERP.
<b>ISOKIT</b> - 75 Chevilles à clou / Slagpluggen - 50 Ecarteurs / Afstandhouder - 10 Raccords / Verbindingsstuks	1600	S	1600755010	75 50 10



NOM NAAM	STOCK STOCK	NR ARTICLE ARTIKEL NR	DIMENSION AFMETING	PIÈCES/EMB. STUKS/VERP.	
<b>ISO CONNECT</b>	1612		1612100030	30 mm	100



NOM NAAM	STOCK STOCK	NR ARTICLE ARTIKEL NR	DIMENSION AFMETING	PIÈCES/EMB. STUKS/VERP.	
<b>ISOCOVER JOINT</b>	1620		1620001005	5 m	1

## ACCESSOIRES TOEBEHOREN



NOM NAAM	STOCK STOCK	NR ARTICLE ARTIKEL NR	DIMENSION AFMETING	PIÈCES/EMB. STUKS/VERP.	
<b>ISOCAL</b>	1671		1671100003	3 mm	100
	1672		1672100005	5 mm	100
	1673		1673100008	8 mm	100
	1674		1674100010	10 mm	100
	1675		1675100015	15 mm	100

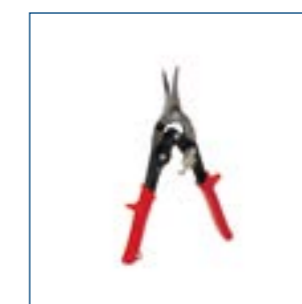
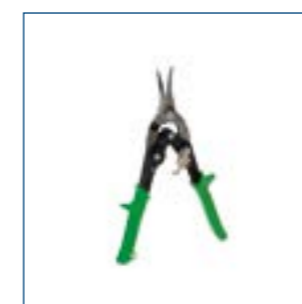
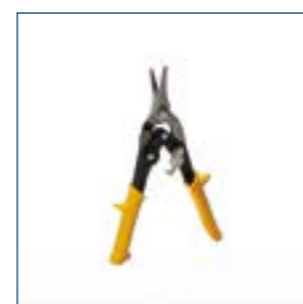

NOM NAAM	STOCK STOCK	NR ARTICLE ARTIKEL NR	DIMENSION AFMETING	PIÈCES/EMB. STUKS/VERP.
<b>PINCE POUR PROFILÉS / PROFIEL SCHAAR</b>	1200		1200006000	6
<b>PINCE POUR PROFILÉS (vert - droitier) / PROFIEL SCHAAR (groen - rechtshandig)</b>	1201		1201005000	5
<b>PINCE POUR PROFILÉS (rouge - gaucher) / PROFIEL SCHAAR (rood - linkshandig)</b>	1202		1202005000	5

## ACCESSOIRES TOEBEHOREN



NOM NAAM	STOCK STOCK	NR ARTICLE ARTIKEL NR	DIMENSION AFMETING	PIÈCES/EMB. STUKS/VERP.
PINCE MULTI COUP / MULTI COUP SCHAAR	1205	1205001000		1



NOM NAAM	STOCK STOCK	NR ARTICLE ARTIKEL NR	DIMENSION AFMETING	PIÈCES/EMB. STUKS/VERP.
PINCE PVC / PVC SCHAAR APU Z12	1210	1210001000		1

## NOTES NOTA



## RECOMMANDATIONS POUR L'EMPLOI DES PROFILÉS DE FINITION DANS LES TRAVAUX AVEC DES ENDUITS INTÉRIEURS ET EXTÉRIEURS.

**DONNÉES TECHNIQUES ET GARANTIE :** Nous garantissons la qualité irréprochable des matières premières utilisées pour fabriquer nos profilés pour enduits (galvanisé sendzimir 275 gr, aluzinc, aluminium, acier inoxydable AISI 304, PVC).

Toutefois, **nous ne pouvons garantir leur résistance contre la corrosion.** En effet, les propriétés chimiques et physiques des enduits présents sur le marché sont diverses et relèvent de la responsabilité de leurs fabricants. C'est pourquoi il faut toujours se renseigner auprès du fabricant d'enduits sur la compatibilité de son produit avec la matière du profilé à utiliser.

**En ce qui concerne l'utilisation des profilés dans des milieux humides et particulièrement à l'extérieur,** il est conseillé de ne jamais employer de profilés galvanisés (\*). Dans la plupart des cas, **on emploiera plutôt des profilés en aluminium laqués, en inox 304 ou en PVC** (il est déconseillé d'utiliser des profilés en alu naturel non laqués dans des cimentages ou enduits à base de ciment).

**NB :**

- ne pas utiliser des outils ou accessoires galvanisés avec des profilés inoxydables pour éviter la rouille erratique.
- toujours stocker les profilés dans un endroit sec et couvert.

**ASSISTANCE TECHNIQUE :** Vous pouvez obtenir gratuitement sur simple demande des **échantillons de profilés, des fiches techniques ou des instructions de pose sur chantier** auprès de votre distributeur qui pourra, si nécessaire, vous mettre en contact avec un de nos délégués technico-commerciaux.

(\*) Veuillez vous référer au tableau « Europrofiles » ci-après afin de vérifier la compatibilité entre les différents types de profilés et les enduits.

NATURE DE L'ENDUIT À BASE DE :	NORME	INTÉRIEUR (1)					EXTÉRIEUR					EXTÉRIEUR INDUSTRIEL/MARIN		
		GALVA	ALU	ALU REVÊTU	INOX	PVC	PVC	GALVA (2)	ALU (3)	ALU REVÊTU	INOX	PVC	INOX	PVC
GYPSE	NBN EN 13279-1	✓	✓	✓	✓	✓	✗	✗	✗	✗	✗	✗	✗	✗
CIMENT ET/OU CHAUX	NBN EN 998-1	✓	✓	✓	✓	✓	✓	✓	(3)	✓	✓	✓	✓	✓
LIANT ORGANIQUE : E.A. SILICATE SILICONE	NBN EN 15824	✓	✓	✓	✓	✓	✓	✗	(3)	✓	✓	✓	✓	✓
		✓	✓	✓	✓	✓	✓	✗	(3)	✓	✓	✓	✓	✓
		✓	✓	✓	✓	✓	✓	✗	(3)	✓	✓	✓	✓	✓

(1) Les parois soumises à des projections d'eau ainsi que les locaux caractérisés par un climat intérieur très humide = inox

(2) L'acier protégé par une couche d'alliage aluzinc (AZ 150) est à exclure en extérieur. La cornière en acier galvanisé Z275, noyée complètement, convient avec un enduit épais (>10 mm) peu capillaire (W2 selon la norme NBN EN 998-1) et pour des parois non soumises à de fortes précipitations. Il est à exclure lorsqu'il s'agit de l'enduit de base mince d'un ETICS.

(3) Ne convient que pour les enduits de base minces des ETICS.

✗ Non applicable.

## EUROPROFILES

### AANBEVELINGEN VOOR HET GEBRUIK VAN METALEN PROFIELEN IN BINNEN- EN BUITEN- PLEISTERINGEN.

**TECHNISCHE GEGEVENS EN GARANTIE:** Al onze profielen zijn geprofileerd uit versneden coils van eerste keuze materiaal met kwaliteiten: sendzimir verzinkt 275 gr/m<sup>2</sup> dubbelzijdig, aluzinc AZ 150, aluminium, inox roestvrijstaal 304, zinc, of PVC.

Alle profielen dienen met de daartoe gebruikelijke producten (roestvrije nagels, kleefmortels, lijmen e.d.) te worden geplaatst volgens de regels der kunst. Het is aangewezen de leverancier van de pleisters of gipsen te raadplegen teneinde de juiste keuze te maken tussen het te gebruiken product en de gewenste kwaliteit van het te plaatsen profiel. Het doel is na te gaan of de te gebruiken pleister en het voorziene profiel elkaar kunnen verdragen.

Onze garantie loopt volgens onze algemene voorwaarden. Uitgesloten van garantie zijn alle schadegevallen te wijten aan corrosie door beschadiging of verkeerd gebruik van onze profielen, door aantasting van (agressieve) pleisters of door onvoldoende verluchting op de werf tijdens en na de plaatsing.

Alle bestellingen worden uitgevoerd volgens onze algemene verkoop- en factuurvoorwaarden, door de koper geacht te zijn gekend en aanvaard. Alle niet conformiteiten dienen ons schriftelijk te worden gemeld.

**NB:** stockeren van profielen in een beschermde en droge omgeving.

**TECHNISCHE BIJSTAND:** Onze technisch- commerciële diensten blijven steeds ter uw beschikking voor bijstand van welke aard ook, bij de handelaar of op de werf. Maak er gebruik van. Technische fiches evenals stalen van onze producten zijn beschikbaar op aanvraag.

(\*) Gelieve steeds de **Europrofiel** tabel te raadplegen teneinde de compatibiliteit na te gaan tussen de verschillende types profielen en pleistermortels.

## EUROPROFILES

PLEISTERTYPE OP BASIS VAN:	NORM	BINNENBEPLEISTERING (1)					BUITENBEPLEISTERING					INDUSTRIE- OF ZEE-KLIMAAT		
		VERZINKT	ALU	BEKLEED ALU	RVS	PVC	PVC	VERZINKT (2)	ALU (3)	BEKLEED ALU	RVS	PVC	RVS	PVC
GIPS	NBN EN 13279-1	✓	✓	✓	✓	✓	✗	✗	✗	✗	✗	✗	✗	✗
CEMENT EN/OF KALK	NBN EN 998-1	✓	✓	✓	✓	✓	✓	✓	(3)	✓	✓	✓	✓	✓
ORGANISCH BINDMIDDEL O.A. SILICAAT SILICONEN	NBN EN 15824	✓	✓	✓	✓	✓	✓	✗	(3)	✓	✓	✓	✓	✓
		✓	✓	✓	✓	✓	✓	✗	(3)	✓	✓	✓	✓	✓
		✓	✓	✓	✓	✓	✓	✗	(3)	✓	✓	✓	✓	✓

(1) Uitzonderd bepleisteringen die blootgesteld worden aan waterprojecties en ruimten die gekenmerkt worden door een zeer vochtig binnenklimaat. Hiervoor wordt dan RVS gekozen.

(2) Staalprofielen bekleed met een aluzinc lagering (AZ 150) zijn uitgesloten voor toepassing in een buitenbepleistering. Verzinkt staal Z275 is enkel geschikt voor pleisterlagen >10 mm, volledig ingebed, bij weinig capillaire bepleisteringen (W2 volgens NBN EN 998-1). Tevens bij toepassingen die niet blootgesteld zijn aan waterinslag en inclusief in een ETICS systeem.

(3) Is slechts van toepassing voor dunne grondpleisters van een ETICS.

✗ Niet van toepassing.

## GLOSSAIRE PAR NUMÉRO DE PRODUIT RANGSCHIKKING VOLGENS ARTIKELNUMMER

N°	NOM NAAM	PAGE PAGINA	N°	NOM NAAM	PAGE PAGINA
0013	CORNER (10 mm)	55	0179	WIDRA APHK (17 mm)	99
0014	CORNER (15 mm)	59	0180	WIDRA APK (17 mm)	90
0015	CORNER (10 mm)	55	0181	WIDRA APS (15 mm)	88
0023	PLASTOP (9 mm)	63	0182	WIDRA IP (10 mm)	57, 82
0103	CORNERPLAC (1 + 6 mm)	6	0191	PLASTO MICRO (1 mm - 9,5 mm)	12
0110	MINIGYP (3 mm)	48	0192	PLASTO MICRO (1 mm - 15 mm)	12
0111	MINIGYP (3 mm)	48	0193	PLASTO MICRO (1 mm - 18 mm)	12
0112	PERFOR (7 mm)	51	0194	PLASTO MICRO (1 mm - 25 mm)	12
0113	MICROMESH (1 mm)	6	0195	PLACSTOP Z (1 mm - 9,5 - 25 mm)	17
0114	GALVAPLAC (1 mm)	7	0200	CONTROL JOINT ALU (1 mm)	19
0118	SUPLEX (15 mm)	59	0203	CORNERPLAC ALU (1 + 6 mm)	6
0119	ANGLEX (10 mm)	57	0211	MINIGYP ALU (3 mm)	48
0120	GALSTOP (3 mm)	60	0212	PERALU (7 mm)	51
0122	GALSTOP (9 mm)	62	0214	CORNER ALU (10 mm)	55, 83
0123	PLASTOP (9 mm)	63	0216	ALUPLAC GWS (3 mm)	116
0124	PLASTOP (12 mm)	64	0217	ALUPLAC (1 mm - 135°)	8
0126	GALSTOP (6 mm)	61	0218	ALUPLAC (1 mm)	7
0127	GALSTOP (6 mm)	61	0219	ANGLALU (10 mm)	57
0128	PLASTO MICRO (1 mm - 12,5 mm)	12	0220	ALUSTOP (3 mm)	60
0130	PLACSTOP L (1 mm - 12,5 mm)	12	0222	ALUSTOP (9 mm)	62, 91
0131	MINIMESH (3 mm)	48	0224	STOP ALU (12 mm)	64, 93
0132	PERGYPLUS (7 mm)	52	0226	ALUSTOP (6 mm)	61
0133	PLACSTOP L (1 mm - 9,5 mm)	12	0227	ALUSTOP (6 mm)	61
0136	PLACSTOP L (1 mm - 15 mm)	12	0229	PLACSTOP ALU (1 mm - 12,5 mm)	13
0138	PERCAR (7 mm)	53	0238	PERCAR ALU (7 mm)	53
0139	PERCAR (7 mm)	54	0240	REGLALU (6 mm)	67
0140	REGLE (6 mm)	67	0241	REGLALU (10 mm)	68, 100
0141	REGLE (10 mm)	68	0262	ALUSTOP (12 mm)	94
0144	REGLE ECO (6 mm)	67	0264	ALUPLAC ECO (1 mm)	7
0152	CADERSTOP L (10 mm)	66	0280	AERO PROFIL (30 X 50 mm)	134
0153	CADERSTOP U (10 mm)	66	0281	AERO PROFIL (30 X 70 mm)	134
0155	CADERFIX (12 mm)	65	0282	AERO PROFIL (30 X 100 mm)	134
0156	CADER RACCORD	65	0283	AERO BAND (60 m X 50 mm)	134
0157	CADER CLIPS	65	0298	ISOBORD ALU (90 mm)	133
0161	CADERPLAC L (1 mm - 12,5 mm)	16	0299	ISOBORD ALU (110 mm)	133
0162	CADERPLAC L (1 mm - 12,5 mm)	16	0300	ISOBORD ALU (130 mm)	133
0163	CADERPLAC L (1 mm - 12,5 mm)	16	0301	ISOBORD ALU (150 mm)	133
0164	GALVAPLAC ECO (1 mm)	7	0302	ISOBORD ALU (160 mm)	133
0165	CADERPLAC L (1 mm - 15 mm)	16	0303	ISOBORD ALU (170 mm)	133
0166	CADERPLAC L (1 mm - 15 mm)	16	0304	ISOBORD ALU (180 mm)	133
0167	CADERPLAC L (1 mm - 15 mm)	16	0305	ISOBORD ALU (190 mm)	133
0168	CADERPLAC L (1 mm - 15 mm)	16	0306	ISOBORD ALU (200 mm)	133
0169	CADERPLAC L (1 mm - 12,5 mm)	16	0307	ISOBORD ALU (210 mm)	133
0170	CADERPLAC L (1 mm - 12,5 mm)	16	0308	ISOBORD ALU (220 mm)	133
0171	CADERPLAC U (1 mm - 12,5 mm)	16	0309	ISOBORD ALU (230 mm)	133
0173	CADERPLAC U (1 mm - 12,5 mm)	17	0310	ISOBORD ALU (240 mm)	133
0174	WIDRA AP (15 mm)	88	0311	ISOBORD ALU (250 mm)	133
0175	WIDRA APA (15 mm)	88	0317	ISOCOVER ALU (90 - 60 mm)	132
0176	WIDRA APB (15 mm)	88	0318	ISOCOVER ALU (110 - 80 mm)	132
0177	WIDRA APBK (17 mm)	90	0319	ISOCOVER ALU (130 - 100 mm)	132
			0320	ISOCOVER ALU (150 - 120 mm)	132

## GLOSSAIRE PAR NUMÉRO DE PRODUIT RANGSCHIKKING VOLGENS ARTIKELNUMMER

N°	NOM NAAM	PAGE PAGINA	N°	NOM NAAM	PAGE PAGINA
0321	ISOCOVER ALU (160 - 130 mm)	132	0423	STOPINOX (10 mm)	63, 92
0322	ISOCOVER ALU (170 - 140 mm)	132	0424	STOPINOX (16 mm)	95
0323	ISOCOVER ALU (180 - 150 mm)	132	0425	INOSTOP (3 mm)	60
0324	ISOCOVER ALU (190 - 160 mm)	132	0426	INOSTOP (6 mm)	61
0325	ISOCOVER ALU (200 - 170 mm)	132	0427	INOSTOP (6 mm)	61
0336	ALUSOCLE - 1 mm (30 mm)	128	0428	WIDRA APE (15 mm)	88
0337	ALUSOCLE - 1 mm (40 mm)	128	0429	WIDRA IPE (10 mm)	57, 82
0338	ALUSOCLE - 1 mm (50 mm)	128	0431	PLACSTOP L INOX (1 mm - 12,5 mm)	12
0339	ALUSOCLE - 1 mm (60 mm)	128	0438	PERCAR INOX (7 mm)	53
0340	ALUSOCLE - 1 mm (70 mm)	128	0440	REGLINOX (6 mm)	67
0341	ALUSOCLE - 1 mm (80 mm)	128	0441	REGLINOX (10 mm)	68, 100
0342	ALUSOCLE - 1 mm (90 mm)	128	0462	INOSTOP (12 mm)	94
0351	ALUSOCLE - 1,2 mm (110 mm)	129	0471	INOSOCLE (30 mm)	130
0352	ALUSOCLE - 1,2 mm (130 mm)	129	0472	INOSOCLE (40 mm)	130
0353	ALUSOCLE - 1,2 mm (150 mm)	129	0473	INOSOCLE (50 mm)	130
0354	ALUSOCLE - 1,2 mm (170 mm)	129	0474	INOSOCLE (60 mm)	130
0355	ALUSOCLE - 1,2 mm (190 mm)	129	0475	INOSOCLE (70 mm)	130
0356	ALUSOCLE - 1,2 mm (210 mm)	129	0476	INOSOCLE (80 mm)	130
0357	ALUSOCLE - 1,2 mm (230 mm)	129	0478	INOSOCLE (100 mm)	130
0358	ALUSOCLE - 1,2 mm (250 mm)	129	0480	INOSOCLE (120 mm)	130
0360	ISOBORD ALU (30 mm)	133	0482	INOSOCLE (140 mm)	130
0361	ISOBORD ALU (40 mm)	133	0484	INOSOCLE (160 mm)	130
0362	ISOBORD ALU (50 mm)	133	0486	INOSOCLE (180 mm)	130
0363	ISOBORD ALU (60 mm)	133	0494	INOPLAC (1 mm)	7
0364	ISOBORD ALU (70 mm)	133	0495	INOPLAC GWS (3 mm)	116
0365	ISOBORD ALU (80 mm)	133	0627	GALSTOP COLOR (6 mm)	61
0366	ISOBORD ALU (100 mm)	133	1012	STUCLOPER ECO (65 m <sup>2</sup> - +/- 1,20 X 54,17 m)	78
0367	ISOBORD ALU (120 mm)	133	1013	POUTRECLIPS	78
0368	ISOBORD ALU (140 mm)	133	1016	STUCLOPER (50 m <sup>2</sup> - +/- 0,9 X 55,55 m)	78
0369	ALUSOCLE - 1,2 mm (220 mm)	129	1017	STUCLOPER (50 m <sup>2</sup> - +/- 1,2 X 41,66 m)	78
0370	ALUSOCLE - 1,2 mm (240 mm)	129	1022	PAPER JOINT TAPE (76 m X 5,2 cm)	29
0389	ISOCOVER ALU (70 - 40 mm)	132	1027	BALKENFIX (50 m X 16,5 cm)	110
0390	ISOCOVER ALU (80 - 50 mm)	132	1028	BALKENFIX (50 m X 20 cm)	110
0391	ISOCOVER ALU (100 - 70 mm)	132	1029	BALKENFIX (50 m X 25 cm)	110
0392	ISOCOVER ALU (120 - 90 mm)	132	1030	BALKENFIX (50 m X 33 cm)	110
0393	ISOCOVER ALU (140 - 110 mm)	132	1033	MICROFIX	29
0394	ALUSOCLE - 1,2 mm (100 mm)	129	1038	STRAITFLEX MUD-PRO2	30
0395	ALUSOCLE - 1,2 mm (120 mm)	129	1039	STRAITFLEX ROLLER 300 MID FLEX	30
0396	ALUSOCLE - 1,2 mm (140 mm)	129	1040	STRAITFLEX EXTENSION POLE	31
0397	ALUSOCLE - 1,2 mm (160 mm)	129	1046	QUICK STICK (76 m)	29
0398	ALUSOCLE - 1,2 mm (180 mm)	129	1151	JOUE DE FENÊTRE / DAGKANT ELEMENT (galva/verzinkt) - 110-145 mm	21
0399	ALUSOCLE - 1,2 mm (200 mm)	129	1152	JOUE DE FENÊTRE / DAGKANT ELEMENT (galva/verzinkt) - 146-170 mm	21
0411	MINIGYP INOX (3 mm)	48, 116	1153	JOUE DE FENÊTRE / DAGKANT ELEMENT (galva/verzinkt) - 171-195 mm	21
0413	CORNER INOX (10 mm)	56, 84	1154	JOUE DE FENÊTRE / DAGKANT ELEMENT (galva/verzinkt) - 196-234 mm	21
0415	CORNER INOX (10 mm)	56, 84	1155	JOUE DE FENÊTRE / DAGKANT ELEMENT (galva/verzinkt) - 235 mm	21
0418	SUPLEX INOX (15 mm)	59, 87			
0419	ANGLINOX (10 mm)	57			
0420	STOPINOX (9 mm)	63, 92			
0421	STOPINOX (12 mm)	64, 93			
0422	INOSTOP (9 mm)	62, 91			

## GLOSSAIRE PAR NUMÉRO DE PRODUIT RANGSCHIKKING VOLGENS ARTIKELNUMMER

N°	NOM NAAM	PAGE PAGINA	N°	NOM NAAM	PAGE PAGINA
1156	JOUE DE FENÊTRE / DAGKANT ELEMENT (galva/verzinkt) - 236-295 mm	21	1251	JOUE DE FENÊTRE / DAGKANT ELEMENT (aluminium) - 110-145 mm	22
1157	JOUE DE FENÊTRE / DAGKANT ELEMENT (galva/verzinkt) - 296-395 mm	21	1252	JOUE DE FENÊTRE / DAGKANT ELEMENT (aluminium) - 146-170 mm	22
1158	JOUE DE FENÊTRE / DAGKANT ELEMENT (galva/verzinkt) - 396-450 mm	21	1253	JOUE DE FENÊTRE / DAGKANT ELEMENT (aluminium) - 171-195 mm	22
1161	JOUE DE FENÊTRE / DAGKANT ELEMENT WR verte/groen (galva/verzinkt) - 110-135 mm	23	1254	JOUE DE FENÊTRE / DAGKANT ELEMENT (aluminium) - 196-234 mm	22
1162	JOUE DE FENÊTRE / DAGKANT ELEMENT WR verte/groen (galva/verzinkt) - 136-155 mm	23	1255	JOUE DE FENÊTRE / DAGKANT ELEMENT (aluminium) - 235 mm	22
1163	JOUE DE FENÊTRE / DAGKANT ELEMENT WR verte/groen (galva/verzinkt) - 156-180 mm	23	1256	JOUE DE FENÊTRE / DAGKANT ELEMENT (aluminium) - 236-295 mm	22
1164	JOUE DE FENÊTRE / DAGKANT ELEMENT WR verte/groen (galva/verzinkt) - 181-215 mm	23	1257	JOUE DE FENÊTRE / DAGKANT ELEMENT (aluminium) - 296-395 mm	22
1165	JOUE DE FENÊTRE / DAGKANT ELEMENT WR verte/groen (galva/verzinkt) - 216-270 mm	23	1258	JOUE DE FENÊTRE / DAGKANT ELEMENT (aluminium) - 396-450 mm	22
1166	JOUE DE FENÊTRE / DAGKANT ELEMENT WR verte/groen (galva/verzinkt) - 271-365 mm	23	1261	JOUE DE FENÊTRE / DAGKANT ELEMENT WR verte/groen (aluminium) - 110-135 mm	24
1167	JOUE DE FENÊTRE / DAGKANT ELEMENT WR verte/groen (galva/verzinkt) - 366-450 mm	23	1262	JOUE DE FENÊTRE / DAGKANT ELEMENT WR verte/groen (aluminium) - 136-155 mm	24
1171	JOUE DE FENÊTRE / DAGKANT ELEMENT WAB orange/oranje (galva/verzinkt) - 110-135 mm	25	1263	JOUE DE FENÊTRE / DAGKANT ELEMENT WR verte/groen (aluminium) - 156-180 mm	24
1172	JOUE DE FENÊTRE / DAGKANT ELEMENT WAB orange/oranje (galva/verzinkt) - 136-155 mm	25	1264	JOUE DE FENÊTRE / DAGKANT ELEMENT WR verte/groen (aluminium) - 181-215 mm	24
1173	JOUE DE FENÊTRE / DAGKANT ELEMENT WAB orange/oranje (galva/verzinkt) - 156-180 mm	25	1265	JOUE DE FENÊTRE / DAGKANT ELEMENT WR verte/groen (aluminium) - 216-270 mm	24
1174	JOUE DE FENÊTRE / DAGKANT ELEMENT WAB orange/oranje (galva/verzinkt) - 181-215 mm	25	1266	JOUE DE FENÊTRE / DAGKANT ELEMENT WR verte/groen (aluminium) - 271-365 mm	24
1175	JOUE DE FENÊTRE / DAGKANT ELEMENT WAB orange/oranje (galva/verzinkt) - 216-270 mm	25	1267	JOUE DE FENÊTRE / DAGKANT ELEMENT WR verte/groen (aluminium) - 366-450 mm	24
1176	JOUE DE FENÊTRE / DAGKANT ELEMENT WAB orange/oranje (galva/verzinkt) - 271-365 mm	25	1271	JOUE DE FENÊTRE / DAGKANT ELEMENT WAB orange/oranje (aluminium) - 110-135 mm	26
1177	JOUE DE FENÊTRE / DAGKANT ELEMENT WAB orange/oranje (galva/verzinkt) - 366-450 mm	25	1272	JOUE DE FENÊTRE / DAGKANT ELEMENT WAB orange/oranje (aluminium) - 136-155 mm	26
1200	PINCE POUR PROFILÉS / PROFIEL SCHAAR	31, 79, 112, 143	1273	JOUE DE FENÊTRE / DAGKANT ELEMENT WAB orange/oranje (aluminium) - 156-180 mm	26
1201	PINCE POUR PROFILÉS / PROFIEL SCHAAR (vert-droitier/groen-rechtshandig)	31, 79, 112, 143	1274	JOUE DE FENÊTRE / DAGKANT ELEMENT WAB orange/oranje (aluminium) - 181-215 mm	26
1202	PINCE POUR PROFILÉS / PROFIEL SCHAAR (rouge-gaucher/rood-linkshandig)	31, 79, 112, 143	1275	JOUE DE FENÊTRE / DAGKANT ELEMENT WAB orange/oranje (aluminium) - 216-270 mm	26
1205	PINCE MULTI COUP / MULTI COUP SCHAAR	32, 79, 112, 144	1276	JOUE DE FENÊTRE / DAGKANT ELEMENT WAB orange/oranje (aluminium) - 271-365 mm	26
1206	PINCE À SERTIR / VERBINDINGSTANG LATT-FIX	80, 113	1277	JOUE DE FENÊTRE / DAGKANT ELEMENT WAB orange/oranje (aluminium) - 366-450 mm	26
1207	PINCE GALTO / GALTO SCHAAR	113	1440	CLIPS S	106
1209	PINCE À SERTIR / VERBINDINGSTANG METAL STUDS	39	1441	CLIPS SLL	106
1210	PINCE PVC / PVC SCHAAR APU Z12	80, 113, 144	1442	CLIPS XL	106
			1600	ISOKIT	142
			1601	ISOFIX GECKO (8 X 100 mm)	138
			1602	ISOFIX DSH K (clou PVC/PVCnagel - 10 X 90 mm)	138
			1603	ISOFIX DSH K (clou PVC/PVCnagel - 10 X 110 mm)	138
			1604	ISOFIX DSH K (clou PVC/PVCnagel - 10 X 130 mm)	138

## GLOSSAIRE PAR NUMÉRO DE PRODUIT RANGSCHIKKING VOLGENS ARTIKELNUMMER

N°	NOM NAAM	PAGE PAGINA	N°	NOM NAAM	PAGE PAGINA
1605	ISOFIX DSH K (clou PVC/PVCnagel - 10 X 140 mm)	138	1643	ISOFIX MAXI TSD-V KN (clou PVC/PVCnagel - 8 X 300 mm)	139
1606	ISOFIX DSH K (clou PVC/PVCnagel - 10 X 150 mm)	138	1671	ISOCALÉ (3 mm)	143
1607	ISOFIX DSH K (clou PVC/PVCnagel - 10 X 160 mm)	138	1672	ISOCALÉ (5 mm)	143
1608	ISOFIX DSH K (clou PVC/PVCnagel - 10 X 170 mm)	138	1673	ISOCALÉ (8 mm)	143
1610	ISOFIX DSH K (clou PVC/PVCnagel - 10 X 190 mm)	138	1674	ISOCALÉ (10 mm)	143
1612	ISO CONNECT	142	1675	ISOCALÉ (15 mm)	143
1620	ISOCOVERT JOINT	142	2001	DILATGAL (10 mm)	71, 101
1621	ISOFIX MAXI TSD (clou métal/metaalnagel - 8 X 80 mm)	140	2002	DILATGAL (15 mm)	102
1622	ISOFIX MAXI TSD (clou métal/metaalnagel - 8 X 100 mm)	140	2003	DILATGAL (20 mm)	103
1623	ISOFIX MAXI TSD (clou métal/metaalnagel - 8 X 120 mm)	140	2004	GALSTOP PVC (10 mm)	92
1624	ISOFIX MAXI TSD (clou métal/metaalnagel - 8 X 140 mm)	140	2005	GALSTOP PVC (15 mm)	94
1625	ISOFIX MAXI TSD (clou métal/metaalnagel - 8 X 160 mm)	140	2006	REND PERFO PVC (10 mm)	97
1626	ISOFIX MAXI TSD (clou métal/metaalnagel - 8 X 180 mm)	140	2007	REND PERFO PVC (15 mm)	98
1627	ISOFIX MAXI TSD (clou métal/metaalnagel - 8 X 200 mm)	140	2008	REND PVC (10 mm)	97
1628	ISOFIX MAXI TSD (clou métal/metaalnagel - 8 X 220 mm)	140	2009	REND PVC (15 mm)	98
1629	ISOFIX MAXI TSD (clou métal/metaalnagel - 8 X 240 mm)	140	2010	REND PVC (20 mm)	99
1630	ISOFIX MAXI TSD (clou métal/metaalnagel - 8 X 260 mm)	140	2012	STOP PVC (10 mm)	93
1631	ISOFIX MAXI TSD (clou métal/metaalnagel - 8 X 280 mm)	140	2013	STOP PVC (15 mm)	94
1632	ISOFIX MAXI TSD (clou métal/metaalnagel - 8 X 300 mm)	140	2014	STOP PVC (20 mm)	95
1633	ISOFIX MAXI TSD-V KN (clou PVC/PVCnagel - 8 X 100 mm)	139	2110	CORNER RONDO PVC (10 mm)	85
1634	ISOFIX MAXI TSD-V KN (clou PVC/PVCnagel - 8 X 120 mm)	139	2112	PERFOR PVC (10 mm)	85
1635	ISOFIX MAXI TSD-V KN (clou PVC/PVCnagel - 8 X 140 mm)	139	2113	CORNER PVC (10 mm)	85
1636	ISOFIX MAXI TSD-V KN (clou PVC/PVCnagel - 8 X 160 mm)	139	2114	CORNER PVC (15 mm)	89
1637	ISOFIX MAXI TSD-V KN (clou PVC/PVCnagel - 8 X 180 mm)	139	2115	CORNER PVC (10 mm)	86
1638	ISOFIX MAXI TSD-V KN (clou PVC/PVCnagel - 8 X 200 mm)	139	2118	SUPLEX PVC (15 mm)	89
1639	ISOFIX MAXI TSD-V KN (clou PVC/PVCnagel - 8 X 220 mm)	139	2170	GALSTOP PVC (20 mm)	96
1640	ISOFIX MAXI TSD-V KN (clou PVC/PVCnagel - 8 X 240 mm)	139	2191	DILATMESH (1 mm)	19
1641	ISOFIX MAXI TSD-V KN (clou PVC/PVCnagel - 8 X 260 mm)	139	2201	COUVRE JOINT À CLIPSER / VOEGAFDEK-KINGSPROFIEL TE CLIPSEN - ALU (plat/vlak - 50 mm - CLIPS S)	104
1642	ISOFIX MAXI TSD-V KN (clou PVC/PVCnagel - 8 X 280 mm)	139	2203	COUVRE JOINT À CLIPSER / VOEGAFDEK-KINGSPROFIEL TE CLIPSEN - ALU (plat/vlak - 70 mm - CLIPS S)	104
			2203	COUVRE JOINT À CLIPSER / VOEGAFDEK-KINGSPROFIEL TE CLIPSEN - ALU (plat/vlak - 70 mm - CLIPS SLL)	104
			2204	COUVRE JOINT À CLIPSER / VOEGAFDEK-KINGSPROFIEL TE CLIPSEN - ALU (plat/vlak - 90 mm - CLIPS S)	104
			2204	COUVRE JOINT À CLIPSER / VOEGAFDEK-KINGSPROFIEL TE CLIPSEN - ALU (plat/vlak - 90 mm - CLIPS SLL)	104
			2205	COUVRE JOINT À CLIPSER / VOEGAFDEK-KINGSPROFIEL TE CLIPSEN - ALU (plat/vlak - 120 mm - CLIPS SLL)	104
			2205	COUVRE JOINT À CLIPSER / VOEGAFDEK-KINGSPROFIEL TE CLIPSEN - ALU (plat/vlak - 120 mm - CLIPS XL)	104
			2211	COUVRE JOINT À CLIPSER / VOEGAFDEK-KINGSPROFIEL TE CLIPSEN - ALU (coin intérieur/binnenhoek 90° - 50 mm - CLIPS S)	104
			2213	COUVRE JOINT À CLIPSER / VOEGAFDEK-KINGSPROFIEL TE CLIPSEN - ALU (coin intérieur/binnenhoek 90° - 70 mm - CLIPS S)	104

## GLOSSAIRE PAR NUMÉRO DE PRODUIT RANGSCHIKING VOLGENS ARTIKELNUMMER

N°	NOM NAAM	PAGE PAGINA	N°	NOM NAAM	PAGE PAGINA
2213	COUVRE JOINT À CLIPSE / VOEGAFDEK-KINGSPROFIEL TE CLIPSEN - ALU (coin intérieur/binnenhoek 90° - 70 mm - CLIPS SLL)	104	3004	PROFILS U HORIZONTAUX / U-HORIZONTALE PROFIELEN U 150/40	34
2214	COUVRE JOINT À CLIPSE / VOEGAFDEK-KINGSPROFIEL TE CLIPSEN - ALU (coin intérieur/binnenhoek 90° - 90 mm - CLIPS S)	104	3005	PROFILS U HORIZONTAUX / U-HORIZONTALE PROFIELEN U 50/40 + FOAM	35
2214	COUVRE JOINT À CLIPSE / VOEGAFDEK-KINGSPROFIEL TE CLIPSEN - ALU (coin intérieur/binnenhoek 90° - 90 mm - CLIPS SLL)	104	3006	PROFILS U HORIZONTAUX / U-HORIZONTALE PROFIELEN U 75/40 + FOAM	35
2215	COUVRE JOINT À CLIPSE / VOEGAFDEK-KINGSPROFIEL TE CLIPSEN - ALU (coin intérieur/binnenhoek 90° - 120 mm - CLIPS SLL)	104	3007	PROFILS U HORIZONTAUX / U-HORIZONTALE PROFIELEN U 100/40 + FOAM	35
2215	COUVRE JOINT À CLIPSE / VOEGAFDEK-KINGSPROFIEL TE CLIPSEN - ALU (coin intérieur/binnenhoek 90° - 120 mm - CLIPS XL)	104	3008	PROFILS U HORIZONTAUX / U-HORIZONTALE PROFIELEN U 125/40 + FOAM	35
2401	DILATINOX (10 mm)	71, 101	3009	PROFILS U HORIZONTAUX / U-HORIZONTALE PROFIELEN U 150/40 + FOAM	35
2402	DILATINOX (15 mm)	102	3010	PROFILS C VERTICAUX / C-VERTICALE PROFIELEN C 50/50	36
2404	DILATINOX (8 mm)	70	3013	RACCORD EN CROIX (plié) / KRUISVERBINDER (geplooid)	39
2406	DILAT PVC INOX MINI (6 + 8 mm)	125	3014	PROFILS U HORIZONTAUX / U-HORIZONTALE PROFIELEN U 70/40 + FOAM	35
2407	DILAT PVC INOX MAXI (6 + 12 mm)	125	3015	PROFILS C VERTICAUX / C-VERTICALE PROFIELEN C 75/50	36
2801	COUVRE JOINT À CLIPSE / VOEGAFDEK-KINGSPROFIEL TE CLIPSEN - PVC (plat/vlak - 50 mm - CLIPS S)	105	3016	PROFILS C VERTICAUX / C-VERTICALE PROFIELEN C 100/50	36
2803	COUVRE JOINT À CLIPSE / VOEGAFDEK-KINGSPROFIEL TE CLIPSEN - PVC (plat/vlak - 70 mm - CLIPS S)	105	3019	PROFILS C POUR PLAFONDS / C-PLAFOND-PROFIELEN C 60/27	38
2803	COUVRE JOINT À CLIPSE / VOEGAFDEK-KINGSPROFIEL TE CLIPSEN - PVC (plat/vlak - 70 mm - CLIPS SLL)	105	3020	PROFILS U POUR PLAFONDS / U-PLAFOND-PROFIELEN U 27/28	38
2804	COUVRE JOINT À CLIPSE / VOEGAFDEK-KINGSPROFIEL TE CLIPSEN - PVC (plat/vlak - 90 mm - CLIPS S)	105	3022	PROFILS U POUR PLAFONDS / U-PLAFOND-PROFIELEN U 27/48	38
2804	COUVRE JOINT À CLIPSE / VOEGAFDEK-KINGSPROFIEL TE CLIPSEN - PVC (plat/vlak - 90 mm - CLIPS SLL)	105	3029	RACCORD EN CROIX (à plier) / KRUISVERBINDER (te plooiën)	39
2811	COUVRE JOINT À CLIPSE / VOEGAFDEK-KINGSPROFIEL TE CLIPSEN - PVC (coin intérieur/binnenhoek 90° - 50 mm - CLIPS S)	105	3030	RACCORD EN LONGUEUR / VERBINDINGS-STUK VOOR PLAFONDPROFIELEN	40
2813	COUVRE JOINT À CLIPSE / VOEGAFDEK-KINGSPROFIEL TE CLIPSEN - PVC (coin intérieur/binnenhoek 90° - 70 mm - CLIPS S)	105	3034	SUSPENTE PLATE POUR STRUCTURE BOIS / VLAKKE OPHANGER VOOR HOUTEN STRUCTUUR (120 mm)	41
2813	COUVRE JOINT À CLIPSE / VOEGAFDEK-KINGSPROFIEL TE CLIPSEN - PVC (coin intérieur/binnenhoek 90° - 70 mm - CLIPS SLL)	105	3035	SUSPENSION RAPIDE ROTATIVE / DRAAIENDE SNELSPANCLIP (pour plafond < à 25 kg/m²/voor plafond < 25 kg/m²)	41
2814	COUVRE JOINT À CLIPSE / VOEGAFDEK-KINGSPROFIEL TE CLIPSEN - PVC (coin intérieur/binnenhoek 90° - 90 mm - CLIPS S)	105	3036	SUSPENTE DOUBLE FIL NON MONTÉE / DUBBEL VEER	42
2814	COUVRE JOINT À CLIPSE / VOEGAFDEK-KINGSPROFIEL TE CLIPSEN - PVC (coin intérieur/binnenhoek 90° - 90 mm - CLIPS SLL)	105	3037	SUSPENTE DOUBLE MONTÉE + FILS / DUBBEL VEER MET DRADEN (30/60 mm)	42
3000	PROFILS U HORIZONTAUX / U-HORIZONTALE PROFIELEN U 50/40	34	3037	SUSPENTE DOUBLE MONTÉE + FILS / DUBBEL VEER MET DRADEN (60/100 mm)	42
3001	PROFILS U HORIZONTAUX / U-HORIZONTALE PROFIELEN U 75/40	34	3038	SUSPENTE PLATE POUR STRUCTURE BOIS / VLAKKE OPHANGER VOOR HOUTEN STRUCTUUR (90 mm)	41
3002	PROFILS U HORIZONTAUX / U-HORIZONTALE PROFIELEN U 100/40	34	3040	TIGE LISSE SANS GILLET / DRAAD ZONDER OOG	43
3003	PROFILS U HORIZONTAUX / U-HORIZONTALE PROFIELEN U 125/40	34	3041	FIL À GILLET / AFHANGDRAAD MET OOG (125 mm)	43
			3041	FIL À GILLET / AFHANGDRAAD MET OOG (250 mm)	43
			3041	FIL À GILLET / AFHANGDRAAD MET OOG (375 mm)	43
			3041	FIL À GILLET / AFHANGDRAAD MET OOG (500 mm)	43

## GLOSSAIRE PAR NUMÉRO DE PRODUIT RANGSCHIKING VOLGENS ARTIKELNUMMER

N°	NOM NAAM	PAGE PAGINA	N°	NOM NAAM	PAGE PAGINA
3041	FIL À GILLET / AFHANGDRAAD MET OOG (750 mm)	43	3090	NONIUS SUSPENTE SUPÉRIEURE / NONIUS BOVENHANGER (1140 mm)	44
3041	FIL À GILLET / AFHANGDRAAD MET OOG (1000 mm)	43	3091	NONIUS SUSPENTE SUPÉRIEURE / NONIUS BOVENHANGER (1340 mm)	44
3041	FIL À GILLET / AFHANGDRAAD MET OOG (1250 mm)	43	3092	NONIUS ÉPINGLE / VEERKLEM VOOR NONIUS	45
3041	FIL À GILLET / AFHANGDRAAD MET OOG (1500 mm)	43	3093	NONIUS SUSPENTE INFÉRIEURE / NONIUS ONDERDEEL HANGER (Pour plafond > à 25 kg/m²/voor plafond > 25 kg/m²)	45
3041	FIL À GILLET / AFHANGDRAAD MET OOG (1750 mm)	43	3097	PROFILS C VERTICAUX / C-VERTICALE PROFIELEN C 70/50	36
3041	FIL À GILLET / AFHANGDRAAD MET OOG (2000 mm)	43	3098	PROFILS C VERTICAUX / C-VERTICALE PROFIELEN C 125/50	37
3043	SUSPENTE PLATE POUR STRUCTURE BOIS / VLAKKE OPHANGER VOOR HOUTEN STRUCTUUR (270 mm)	41	3099	PROFILS C VERTICAUX / C-VERTICALE PROFIELEN C 150/50	37
3044	SUSPENTE SUR BOIS / DIRECT HANGER (60 mm)	40	3351	ALUSOCLE - 1 mm (110 mm)	128
3045	SUSPENTE SUR BOIS / DIRECT HANGER (125 mm)	40	3352	ALUSOCLE - 1 mm (130 mm)	128
3046	SUSPENTE SUR BOIS / DIRECT HANGER (200 mm)	40	3353	ALUSOCLE - 1 mm (150 mm)	128
3049	CHEVILLES À FRAPPER / SLAGPLUGGEN 5-35 mm (seau/emmer)	32	3354	ALUSOCLE - 1 mm (170 mm)	128
3050	CHEVILLES À FRAPPER / SLAGPLUGGEN 6-40 mm (petit seau/kleine emmer)	33	3355	ALUSOCLE - 1 mm (190 mm)	128
3051	CHEVILLES À FRAPPER / SLAGPLUGGEN 6-40 mm (seau/emmer)	32	3356	ALUSOCLE - 1 mm (210 mm)	128
3052	CHEVILLE EXPRESS POUR PLAFOND / EXPRESS PLAFONDPLUG	46	3357	ALUSOCLE - 1 mm (230 mm)	128
3053	CHEVILLES À FRAPPER / SLAGPLUGGEN 6-60 mm (petit seau/kleine emmer)	33	3358	ALUSOCLE - 1 mm (250 mm)	128
3054	CHEVILLES À FRAPPER / SLAGPLUGGEN 6-60 mm (seau/emmer)	32	3369	ALUSOCLE - 1 mm (220 mm)	128
3055	CHEVILLES À FRAPPER / SLAGPLUGGEN 8-60 mm (petit sachet/klein zakje)	33	3370	ALUSOCLE - 1 mm (240 mm)	128
3056	CHEVILLES À FRAPPER / SLAGPLUGGEN 8-80 mm (petit sachet/klein zakje)	33	3394	ALUSOCLE - 1 mm (100 mm)	128
3061	MS CLIPS / VOEGEN CLIPS	44	3395	ALUSOCLE - 1 mm (120 mm)	128
3070	PROFILS U HORIZONTAUX / U-HORIZONTALE PROFIELEN U 70/40	34	3396	ALUSOCLE - 1 mm (140 mm)	128
3074	STUDS FOAM (25 mm X 10 m)	46	3397	ALUSOCLE - 1 mm (160 mm)	128
3081	NONIUS SUSPENTE SUPÉRIEURE / NONIUS BOVENHANGER (140 mm)	44	3398	ALUSOCLE - 1 mm (180 mm)	128
3083	NONIUS SUSPENTE SUPÉRIEURE / NONIUS BOVENHANGER (340 mm)	44	3399	ALUSOCLE - 1 mm (200 mm)	128
3084	NONIUS SUSPENTE SUPÉRIEURE / NONIUS BOVENHANGER (440 mm)	44	4040	ARMATEX (100 gr/m²) - 100 m X 12,5 cm	76
3085	NONIUS SUSPENTE SUPÉRIEURE / NONIUS BOVENHANGER (540 mm)	44	4041	ARMATEX (100 gr/m²) - 100 m X 25 cm	76
3086	NONIUS SUSPENTE SUPÉRIEURE / NONIUS BOVENHANGER (640 mm)	44	4042	ARMATEX (100 gr/m²) - 100 m X 50 cm	76
3087	NONIUS SUSPENTE SUPÉRIEURE / NONIUS BOVENHANGER (740 mm)	44	4043	ARMATEX (100 gr/m²) - 100 m X 100 cm	76
3088	NONIUS SUSPENTE SUPÉRIEURE / NONIUS BOVENHANGER (840 mm)	44	4044	ARMATEX (75 gr/m²) - 100 m X 12,5 cm	76
3089	NONIUS SUSPENTE SUPÉRIEURE / NONIUS BOVENHANGER (940 mm)	44	4045	ARMATEX (75 gr/m²) - 100 m X 25 cm	76
			4046	ARMATEX (75 gr/m²) - 100 m X 50 cm	76
			4047	ARMATEX (75 gr/m²) - 100 m X 100 cm	76
			4090	JOINT TAPE BESTAPE	27
			4140	FASSATEX (blanc/wit - 145 gr/m² - 50 m X 100 cm)	110
			4141	FASSATEX (bleu/blauw - 145 gr/m² - 50 m X 100 cm)	110
			4142	FASSATEX (orange/oranje - 145 gr/m² - 50 m X 100 cm)	110
			4143	FASSATEX (blanc/wit - 145 gr/m² - 50 m X 33 cm)	110
			4144	FASSATEX (blanc/wit - 145 gr/m² - 50 m X 50 cm)	110
			4145	FASSATEX (bleu/blauw - 145 gr/m² - 50 m X 33 cm)	110
			4146	FASSATEX (bleu/blauw - 145 gr/m² - 50 m X 50 cm)	110
			4165	ISOTEX (blanc/wit - 160 gr/m² - 50 m X 100 cm)	141

## GLOSSAIRE PAR NUMÉRO DE PRODUIT RANGSCHIKKING VOLGENS ARTIKELNUMMER

N°	NOM NAAM	PAGE PAGINA
4166	ISOTEX (orange/oranje - 160 gr/m <sup>2</sup> - 50 m X 100 cm)	141
4167	ISOTEX (blanc/wit - 160 gr/m <sup>2</sup> - 50 m X 110 cm)	141
4170	MOUCHOIR (plat/vlak - 33 X 50 cm)	141
4171	MOUCHOIR (coin/hoek - 10 cm)	141
4172	MOUCHOIR (coin/hoek - 20 cm)	141
4190	FIBATAPE (90 m X 100 mm)	27
4210	FASSATEX (blanc/wit - 200 gr/m <sup>2</sup> - 50 m X 100 cm)	111
4220	FASSATEX (blanc/wit - 220 gr/m <sup>2</sup> - 50 m X 100 cm)	111
4330	FASSATEX (blanc/wit - 330 gr/m <sup>2</sup> - 25 m X 100 cm)	111
4820	FIBATAPE (20 m X 48 mm)	27
4845	FIBATAPE (45 m X 48 mm)	27
4846	FIBATAPE APPLICATOR	30
4890	FIBATAPE (90 m X 48 mm)	27
4892	FIBATAPE MOLD X10 (90 m X 48 mm)	27
4894	FIBATAPE PERFECT FINISH (90 m X 48 mm)	28
4905	CHAPNET VERTEX (50 m X 1 m)	77
4910	CHAPNET VERTEX (100 m X 1 m)	77
5230	UNIFLEX CORNER (1 mm)	9
5237	UNIFLEX CORNER PVC (1 mm)	9
5300	STRAITFLEX MID FLEX 300 (1 mm)	9
5301	PAPER CORNER BEAD (1 mm)	9
5302	BIG BULL (1 mm)	10
5303	STRAITFLEX ARCH-FLEX 333 (1 mm)	10
5305	PAPER STOP BEAD (1 mm - 12,5 mm)	15
5306	CORNER BEAD WET-STICK (1 mm)	10
5307	WET-FLEX (1 mm)	11
6000	GRIP-LATT PLUS (20 mm)	75, 108
6018	GALTO (25 mm)	108
6028	GALTO (25 mm)	109
6100	NER-LATT (20 mm)	75, 108
6400	NER-LATT INOX (20 mm)	75, 108
6418	GALTO INOX (25 mm)	108
6428	GALTO INOX (25 mm)	109
6828	GALTO PVC (25 mm)	109
8001	CORNER BEAD PVC (1 mm)	8
8003	CORNER BEAD PVC (3 mm)	49
8004	CORNER BEAD PVC (4 mm)	119
8006	CORNER BEAD PVC (6 mm)	119
8010	CORNER BEAD PVC (10 mm)	58, 86
8011	CORNER BEAD PVC (10 mm)	58, 87
8015	CORNER BEAD PVC (15 mm)	59, 89
8025	PLACSTOP PVC (1 mm - 12,5 mm)	13
8026	CADERPLAC L PVC (1 mm - 9,5 - 25 mm)	17
8027	CADERPLAC U PVC (1 mm - 9,5 - 25 mm)	18
8030	DILAT PVC GWS (6 mm)	124
8031	REGLE PVC (6 mm)	68
8032	REGLE PVC (10 mm)	69, 100
8034	DILAT PVC GWS "V" (3 mm)	124

N°	NOM NAAM	PAGE PAGINA
8035	DILAT PVC GWS "E" (3 mm)	124
8066	CORNER BEAD PVC (6 mm)	49
8104	APU W23 / STANDARD-UV (4 mm)	135
8108	PROFI MINI PRO (9 mm)	73
8112	APU A13 / MIDI (12 mm)	74, 107
8113	GWS EXTRA (3 mm)	116
8114	PER PVC MAXI GWS (6 mm)	120
8115	APU A14 / UNIVERSAL (15 mm)	107
8123	PER PVC RONDO GWS (3 mm)	117
8124	CORNER REND PVC GWS (3 mm)	121
8125	PLACSTOP PVC (1 mm - 12,5 mm)	13
8126	PLACSTOP PVC (9,5 mm)	14
8127	PLACSTOP PVC (12,5 mm)	14
8128	PLACSTOP PVC (15 mm)	14
8129	PER PVC FLEX GWS (3 mm)	117
8166	PROFI INTER PRO (6 mm)	72
8167	PROFI INTER GWS PRO (6 mm)	136
8168	PROFI MINI GWS PRO (9 mm)	137
8201	RONDO PLAC PVC (1 mm)	8
8207	RONDO GYP PVC (6 mm)	50
8211	PER PVC GWS PRO (3 mm - bleu/blauw)	117
8212	PER PVC GWS PRO (3 mm - jaune/geel)	117
8213	PER PVC GWS PRO (3 mm - blanc/wit)	117
8214	PER PVC GWS PRO (3 mm - orange/oranje)	117
8215	PLACSTOP PVC (1 mm - 15 mm)	13
8219	PER PVC GWS PRO 10 X 23 mm (3 mm - blanc/wit)	118
8220	PER PVC GWS PRO 10 X 30 mm (3 mm - blanc/wit)	118
8225	PLACSTOP RONDO PVC (1 mm - 12,5 mm)	14
8231	STOP ISO GWS (10 mm)	127
8233	STOP ISO GWS (3 mm)	126
8234	STOP ISO GWS (6 mm)	126
8235	STOP ISO GWS DUO PRO (3 / 6 mm)	126
8236	STOP ISO GWS (6 mm)	127
8289	APU W38 / PUR-FIX PRO K (10 mm)	137
8299	APU W38 / PUR-FIX PRO S (3 mm)	135
8313	GWS ISOCORNER (3 mm)	118
8403	CORNER BEAD PVC ECO (3 mm)	49, 119
8406	CORNER BEAD PVC ECO (6 mm)	50, 120
8410	CORNER BEAD PVC ECO (10 mm)	58, 87
8413	PER PVC GWS ECO (3 mm - blanc/wit)	117
8424	CORNER REND PVC GWS ECO (3 mm)	121
8441	SOCLE PVC GWS PRO (80 mm)	131
8443	SOCLE PVC GWS PRO (100 mm)	131
8453	SOCLE PVC GWS PRO (150 mm)	131
8466	CORNER BEAD PVC ECO INTER (6 mm)	50
8495	SOCLE PVC GWS PRO (120 mm)	131
8496	SOCLE PVC GWS PRO (140 mm)	131
8497	SOCLE PVC GWS PRO (160 mm)	131
8498	SOCLE PVC GWS PRO (180 mm)	131

## GLOSSAIRE PAR NUMÉRO DE PRODUIT RANGSCHIKKING VOLGENS ARTIKELNUMMER

N°	NOM NAAM	PAGE PAGINA
8499	SOCLE PVC GWS PRO (200 mm)	131
8501	DILATPLAC PVC (1 mm)	19
8503	DILAT PVC (3 mm)	70
8506	DILAT PVC (6 mm)	70
8510	DILAT PVC (10 mm)	71, 101
8511	FLEX JOINT PVC (1 mm)	20
8515	DILAT PVC (15 mm)	102
8610	STOP BEAD PVC (10 mm)	64, 93
8615	STOP BEAD PVC (15 mm)	95
8620	STOP BEAD PVC (20 mm)	96
8633	STOP BEAD PVC (3 mm)	60
8666	STOP BEAD PVC (6 mm)	62
8703	STOP PVC GWS PRO (3 mm)	122
8704	STOP PVC GWS PRO (6 mm)	122
8705	STOP PVC GWS PRO (10 mm)	122
8706	STOP PVC GWS PRO (15 mm)	123
8710	REND BEAD PVC (10 mm)	97
8715	REND BEAD PVC (15 mm)	98
8804	APU W23+ / STANDARD-PLUS (4 mm)	135
8808	PROFI INTER GWS LIPPE (6 mm)	136
8809	PROFI MINI GWS LIPPE (9 mm)	137
8812	PLACSTOP TAPE PVC (1 mm - 12,5 mm)	14
8815	PLACSTOP TAPE PVC (1 mm - 15 mm)	14
8825	PLACSTOP LIPPE PVC (1 mm - 12,5 mm)	15
8866	PROFI INTER ECO LIPPE (6 mm)	72
8888	PROFI MINI LIPPE (9 mm)	73
9001	DILATGAL COLOR (10 mm - beige)	101
9002	DILATGAL COLOR (15 mm - beige)	102
9003	DILATGAL COLOR (20 mm - beige)	103
9004	DILAT PVC GWS (6 mm - beige)	124
9005	DILAT PVC GWS (6 mm - gris/grijs)	124
9010	CORNER BEAD PVC (10 mm - gris/grijs)	86
9011	CORNER BEAD PVC (10 mm - gris/grijs)	87
9012	CORNER BEAD PVC (10 mm - beige)	86
9013	CORNER BEAD PVC (10 mm - beige)	87
9015	CORNER BEAD PVC (15 mm - gris/grijs)	89
9016	CORNER BEAD PVC (15 mm - beige)	89
9110	CORNER RONDO PVC COLOR (10 mm)	85
9115	CORNER PVC COLOR (10 mm - gris/grijs)	86
9115	CORNER PVC COLOR (10 mm - beige)	86
9160	GALSTOP PVC COLOR (10 mm - gris/grijs)	92
9160	GALSTOP PVC COLOR (10 mm - beige)	92
9165	GALSTOP PVC COLOR (15 mm - gris/grijs)	94
9165	GALSTOP PVC COLOR (15 mm - beige)	94
9174	WIDRA APP COLOR (15 mm - blanc/wit)	88
9401	DILATINOX COLOR (10 mm - beige)	101
9402	DILATINOX COLOR (15 mm - beige)	102
9510	DILAT PVC (10 mm - gris/grijs)	101
9511	DILAT PVC (10 mm - beige)	101
9515	DILAT PVC (15 mm - gris/grijs)	102
9516	DILAT PVC (15 mm - beige)	102

N°	NOM NAAM	PAGE PAGINA
9610	STOP BEAD PVC (10 mm - gris/grijs)	93
9611	STOP BEAD PVC (10 mm - beige)	93
9615	STOP BEAD PVC (15 mm - gris/grijs)	95
9616	STOP BEAD PVC (15 mm - beige)	95
9710	REND BEAD PVC (10 mm - gris/grijs)	97
9711	REND BEAD PVC (10 mm - beige)	97
9715	REND BEAD PVC (15 mm - gris/grijs)	98
9716	REND BEAD PVC (15 mm - beige)	98
9808	PROFI INTER GWS LIPPE COLOR (6 mm)	136
9809	PROFI MINI GWS LIPPE COLOR (9 mm)	137
9914	CORNER ALU COLOR (10 mm - blanc cassé/ gebroken wit)	83
9914	CORNER ALU COLOR (10 mm - beige clair/licht beige)	83
9914	CORNER ALU COLOR (10 mm - beige sable/zand beige)	83
9914	CORNER ALU COLOR (10 mm - beige ocre/oker beige)	83
9914	CORNER ALU COLOR (10 mm - beige saumon/zalm beige)	83
9914	CORNER ALU COLOR (10 mm - gris beige/beige grijs)	83
9914	CORNER ALU COLOR (10 mm - bleu clair/licht blauw)	83
9914	CORNER ALU COLOR (10 mm - rose clair/licht rose)	83
9914	CORNER ALU COLOR (10 mm - gris ciment/cement grijs)	83
9914	CORNER ALU COLOR (10 mm - rouge corail/koraal rood)	83
9922	ALUSTOP COLOR (9 mm - blanc cassé/gebroken wit)	91
9922	ALUSTOP COLOR (9 mm - beige clair/licht beige)	91
9922	ALUSTOP COLOR (9 mm - beige sable/zand beige)	91
9922	ALUSTOP COLOR (9 mm - beige ocre/oker beige)	91
9922	ALUSTOP COLOR (9 mm - beige saumon/zalm beige)	91
9922	ALUSTOP COLOR (9 mm - gris beige/beige grijs)	91
9922	ALUSTOP COLOR (9 mm - bleu clair/licht blauw)	91
9922	ALUSTOP COLOR (9 mm - rose clair/licht rose)	91
9922	ALUSTOP COLOR (9 mm - gris ciment/cement grijs)	91
9922	ALUSTOP COLOR (9 mm - rouge corail/koraal rood)	91

## GLOSSAIRE PAR ORDRE ALPHABÉTIQUE ALFABETISCHE RANGSCHIKKING

NOM NAAM	N°	PAGE PAGINA	NOM NAAM	N°	PAGE PAGINA
AERO BAND (60 m X 50 mm)	0283	134	ALUSOCLE - 1,2 mm (200 mm)	0399	129
AERO PROFIL (30 X 50 mm)	0280	134	ALUSOCLE - 1,2 mm (210 mm)	0356	129
AERO PROFIL (30 X 70 mm)	0281	134	ALUSOCLE - 1,2 mm (220 mm)	0369	129
AERO PROFIL (30 X 100 mm)	0282	134	ALUSOCLE - 1,2 mm (230 mm)	0357	129
AFHANGDRAAD MET OOG (125 mm)	3041	43	ALUSOCLE - 1,2 mm (240 mm)	0370	129
AFHANGDRAAD MET OOG (250 mm)	3041	43	ALUSOCLE - 1,2 mm (250 mm)	0358	129
AFHANGDRAAD MET OOG (375 mm)	3041	43	ALUSTOP (3 mm)	0220	60
AFHANGDRAAD MET OOG (500 mm)	3041	43	ALUSTOP (6 mm)	0226	61
AFHANGDRAAD MET OOG (750 mm)	3041	43	ALUSTOP (6 mm)	0227	61
AFHANGDRAAD MET OOG (1000 mm)	3041	43	ALUSTOP (9 mm)	0222	62, 91
AFHANGDRAAD MET OOG (1250 mm)	3041	43	ALUSTOP (12 mm)	0262	94
AFHANGDRAAD MET OOG (1500 mm)	3041	43	ALUSTOP COLOR (9 mm - beige clair/licht beige)	9922	91
AFHANGDRAAD MET OOG (1750 mm)	3041	43	ALUSTOP COLOR (9 mm - beige ocre/oker beige)	9922	91
AFHANGDRAAD MET OOG (2000 mm)	3041	43	ALUSTOP COLOR (9 mm - beige sable/zand beige)	9922	91
ALUPLAC (1 mm - 135°)	0217	8	ALUSTOP COLOR (9 mm - beige saumon/zalm beige)	9922	91
ALUPLAC (1 mm)	0218	7	ALUSTOP COLOR (9 mm - beige cassé/gebroken wit)	9922	91
ALUPLAC ECO (1 mm)	0264	7	ALUSTOP COLOR (9 mm - blanc cassé/gebroken wit)	9922	91
ALUPLAC GWS (3 mm)	0216	116	ALUSTOP COLOR (9 mm - bleu clair/licht blauw)	9922	91
ALUSOCLE - 1 mm (30 mm)	0336	128	ALUSTOP COLOR (9 mm - gris beige/beige grijs)	9922	91
ALUSOCLE - 1 mm (40 mm)	0337	128	ALUSTOP COLOR (9 mm - gris ciment/cement grijs)	9922	91
ALUSOCLE - 1 mm (50 mm)	0338	128	ALUSTOP COLOR (9 mm - rose clair/licht rose)	9922	91
ALUSOCLE - 1 mm (60 mm)	0339	128	ALUSTOP COLOR (9 mm - rouge corail/koraal rood)	9922	91
ALUSOCLE - 1 mm (70 mm)	0340	128	ANGLALU (10 mm)	0219	57
ALUSOCLE - 1 mm (80 mm)	0341	128	ANGLEX (10 mm)	0119	57
ALUSOCLE - 1 mm (90 mm)	0342	128	ANGLINOX (10 mm)	0419	57
ALUSOCLE - 1 mm (100 mm)	3394	128	APU A13 / MIDI (12 mm)	8112	74, 107
ALUSOCLE - 1 mm (110 mm)	3351	128	APU A14 / UNIVERSAL (15 mm)	8115	107
ALUSOCLE - 1 mm (120 mm)	3395	128	APU W23 / STANDARD-UV (4 mm)	8104	135
ALUSOCLE - 1 mm (130 mm)	3352	128	APU W23+ / STANDARD-PLUS (4 mm)	8804	135
ALUSOCLE - 1 mm (140 mm)	3396	128	APU W38 / PUR-FIX PRO K (10 mm)	8289	137
ALUSOCLE - 1 mm (150 mm)	3353	128	APU W38 / PUR-FIX PRO S (3 mm)	8299	135
ALUSOCLE - 1 mm (160 mm)	3397	128	ARMATEX (75 gr/m²) - 100 m X 12,5 cm	4044	76
ALUSOCLE - 1 mm (170 mm)	3354	128	ARMATEX (75 gr/m²) - 100 m X 25 cm	4045	76
ALUSOCLE - 1 mm (180 mm)	3398	128	ARMATEX (75 gr/m²) - 100 m X 50 cm	4046	76
ALUSOCLE - 1 mm (190 mm)	3355	128	ARMATEX (75 gr/m²) - 100 m X 100 cm	4047	76
ALUSOCLE - 1 mm (200 mm)	3399	128	ARMATEX (100 gr/m²) - 100 m X 12,5 cm	4040	76
ALUSOCLE - 1 mm (210 mm)	3356	128	ARMATEX (100 gr/m²) - 100 m X 25 cm	4041	76
ALUSOCLE - 1 mm (220 mm)	3369	128	ARMATEX (100 gr/m²) - 100 m X 50 cm	4042	76
ALUSOCLE - 1 mm (230 mm)	3357	128	ARMATEX (100 gr/m²) - 100 m X 100 cm	4043	76
ALUSOCLE - 1 mm (240 mm)	3370	128	BALKENFIX (50 m X 16,5 cm)	1027	110
ALUSOCLE - 1 mm (250 mm)	3358	128	BALKENFIX (50 m X 20 cm)	1028	110
ALUSOCLE - 1,2 mm (100 mm)	0394	129	BALKENFIX (50 m X 25 cm)	1029	110
ALUSOCLE - 1,2 mm (110 mm)	0351	129	BALKENFIX (50 m X 33 cm)	1030	110
ALUSOCLE - 1,2 mm (120 mm)	0395	129	BIG BULL (1 mm)	5302	10
ALUSOCLE - 1,2 mm (130 mm)	0352	129	CADER CLIPS	0157	65
ALUSOCLE - 1,2 mm (140 mm)	0396	129			
ALUSOCLE - 1,2 mm (150 mm)	0353	129			
ALUSOCLE - 1,2 mm (160 mm)	0397	129			
ALUSOCLE - 1,2 mm (170 mm)	0354	129			
ALUSOCLE - 1,2 mm (180 mm)	0398	129			
ALUSOCLE - 1,2 mm (190 mm)	0355	129			

## GLOSSAIRE PAR ORDRE ALPHABÉTIQUE ALFABETISCHE RANGSCHIKKING

NOM NAAM	N°	PAGE PAGINA	NOM NAAM	N°	PAGE PAGINA
CADER RACCORD	0156	65	CORNER ALU COLOR (10 mm - rouge corail/ koraal rood)	9914	83
CADERFIX (12 mm)	0155	65	CORNER BEAD PVC (1 mm)	8001	8
CADERPLAC L (1 mm - 12,5 mm)	0161	16	CORNER BEAD PVC (3 mm)	8003	49
CADERPLAC L (1 mm - 12,5 mm)	0162	16	CORNER BEAD PVC (4 mm)	8004	119
CADERPLAC L (1 mm - 12,5 mm)	0163	16	CORNER BEAD PVC (6 mm)	8006	119
CADERPLAC L (1 mm - 12,5 mm)	0169	16	CORNER BEAD PVC (6 mm)	8066	49
CADERPLAC L (1 mm - 12,5 mm)	0170	16	CORNER BEAD PVC (10 mm)	8010	58, 86
CADERPLAC L (1 mm - 15 mm)	0165	16	CORNER BEAD PVC (10 mm)	8011	58, 87
CADERPLAC L (1 mm - 15 mm)	0166	16	CORNER BEAD PVC (10 mm - beige)	9012	86
CADERPLAC L (1 mm - 15 mm)	0167	16	CORNER BEAD PVC (10 mm - beige)	9013	87
CADERPLAC L (1 mm - 15 mm)	0168	16	CORNER BEAD PVC (10 mm - gris/grijs)	9010	86
CADERPLAC L PVC (1 mm - 9,5 - 25 mm)	8026	17	CORNER BEAD PVC (10 mm - gris/grijs)	9011	87
CADERPLAC U (1 mm - 12,5 mm)	0171	16	CORNER BEAD PVC (15 mm)	8015	59, 89
CADERPLAC U (1 mm - 12,5 mm)	0173	17	CORNER BEAD PVC (15 mm - beige)	9016	89
CADERPLAC U PVC (1 mm - 9,5 - 25 mm)	8027	18	CORNER BEAD PVC (15 mm - gris/grijs)	9015	89
CADERSTOP L (10 mm)	0152	66	CORNER BEAD PVC ECO (3 mm)	8403	49, 119
CADERSTOP U (10 mm)	0153	66	CORNER BEAD PVC ECO (6 mm)	8406	50, 120
CHAPNET VERTEX (50 m X 1 m)	4905	77	CORNER BEAD PVC ECO (10 mm)	8410	58, 87
CHAPNET VERTEX (100 m X 1 m)	4910	77	CORNER BEAD PVC ECO INTER (6 mm)	8466	50
CHEVILLE EXPRESS POUR PLAFOND	3052	46	CORNER BEAD WET STICK (1 mm)	5306	10
CHEVILLES À FRAPPER 5-35 mm (seau)	3049	32	CORNER INOX (10 mm)	0413	56, 84
CHEVILLES À FRAPPER 6-40 mm (petit seau)	3050	33	CORNER INOX (10 mm)	0415	56, 84
CHEVILLES À FRAPPER 6-40 mm (seau)	3051	32	CORNER PVC (10 mm)	2113	85
CHEVILLES À FRAPPER 6-60 mm (petit seau)	3053	33	CORNER PVC (10 mm)	2115	86
CHEVILLES À FRAPPER 6-60 mm (seau)	3054	32	CORNER PVC (15 mm)	2114	89
CHEVILLES À FRAPPER 8-60 mm (petit sachet)	3055	33	CORNER PVC COLOR (10 mm - beige)	9115	86
CHEVILLES À FRAPPER 8-80 mm (petit sachet)	3056	33	CORNER PVC COLOR (10 mm - gris/grijs)	9115	86
CLIPS S	1440	106	CORNER REND PVC GWS (3 mm)	8124	121
CLIPS SLL	1441	106	CORNER REND PVC GWS ECO (3 mm)	8424	121
CLIPS XL	1442	106	CORNER RONDO PVC (10 mm)	2110	85
CONTROL JOINT ALU (1 mm)	0200	19	CORNER RONDO PVC COLOR (10 mm)	9110	85
CORNER (10 mm)	0013	55	CORNERPLAC (1 + 6 mm)	0103	6
CORNER (10 mm)	0015	55	CORNERPLAC ALU (1 + 6 mm)	0203	6
CORNER (15 mm)	0014	59	COUVRE JOINT À CLIPSER - ALU (coin intérieur 90° - 50 mm - CLIPS S)	2211	104
CORNER ALU (10 mm)	0214	55, 83	COUVRE JOINT À CLIPSER - ALU (coin intérieur 90° - 70 mm - CLIPS S)	2213	104
CORNER ALU COLOR (10 mm - beige clair/licht beige)	9914	83	COUVRE JOINT À CLIPSER - ALU (coin intérieur 90° - 70 mm - CLIPS SLL)	2213	104
CORNER ALU COLOR (10 mm - beige ocre/oker beige)	9914	83	COUVRE JOINT À CLIPSER - ALU (coin intérieur 90° - 90 mm - CLIPS S)	2214	104
CORNER ALU COLOR (10 mm - beige sable/ zand beige)	9914	83	COUVRE JOINT À CLIPSER - ALU (coin intérieur 90° - 90 mm - CLIPS SLL)	2214	104
CORNER ALU COLOR (10 mm - beige saumon/ zalm beige)	9914	83	COUVRE JOINT À CLIPSER - ALU (coin intérieur 90° - 120 mm - CLIPS SLL)	2215	104
CORNER ALU COLOR (10 mm - blanc cassé/ gebroken wit)	9914	83	COUVRE JOINT À CLIPSER - ALU (coin intérieur 90° - 120 mm - CLIPS XL)	2215	104
CORNER ALU COLOR (10 mm - bleu clair/licht blauw)	9914	83	COUVRE JOINT À CLIPSER - ALU (plat - 50 mm - CLIPS S)	2201	104
CORNER ALU COLOR (10 mm - gris beige/ beige grijs)	9914	83	COUVRE JOINT À CLIPSER - ALU (plat - 70 mm - CLIPS S)	2203	104
CORNER ALU COLOR (10 mm - gris ciment/ ciment grijs)	9914	83			
CORNER ALU COLOR (10 mm - rose clair/licht rose)	9914	83			

## GLOSSAIRE PAR ORDRE ALPHABÉTIQUE ALFABETISCHE RANGSCHIKKING

NOM NAAM	N°	PAGE PAGINA	NOM NAAM	N°	PAGE PAGINA
COUVRE JOINT À CLIPSEUR - ALU (plat - 70 mm - CLIPS SLL)	2203	104	DAGKANT ELEMENT WAB oranje (aluminium) - 110-135 mm	1271	26
COUVRE JOINT À CLIPSEUR - ALU (plat - 90 mm - CLIPS S)	2204	104	DAGKANT ELEMENT WAB oranje (aluminium) - 136-155 mm	1272	26
COUVRE JOINT À CLIPSEUR - ALU (plat - 90 mm - CLIPS SLL)	2204	104	DAGKANT ELEMENT WAB oranje (aluminium) - 156-180 mm	1273	26
COUVRE JOINT À CLIPSEUR - ALU (plat - 120 mm - CLIPS SLL)	2205	104	DAGKANT ELEMENT WAB oranje (aluminium) - 181-215 mm	1274	26
COUVRE JOINT À CLIPSEUR - ALU (plat - 120 mm - CLIPS XL)	2205	104	DAGKANT ELEMENT WAB oranje (aluminium) - 216-270 mm	1275	26
COUVRE JOINT À CLIPSEUR - PVC (coin intérieur 90° - 50 mm - CLIPS S)	2811	105	DAGKANT ELEMENT WAB oranje (aluminium) - 271-365 mm	1276	26
COUVRE JOINT À CLIPSEUR - PVC (coin intérieur 90° - 70 mm - CLIPS S)	2813	105	DAGKANT ELEMENT WAB oranje (aluminium) - 366-450 mm	1277	26
COUVRE JOINT À CLIPSEUR - PVC (coin intérieur 90° - 70 mm - CLIPS SLL)	2813	105	DAGKANT ELEMENT WAB oranje (verzinkt) - 110-135 mm	1171	25
COUVRE JOINT À CLIPSEUR - PVC (coin intérieur 90° - 90 mm - CLIPS S)	2814	105	DAGKANT ELEMENT WAB oranje (verzinkt) - 136-155 mm	1172	25
COUVRE JOINT À CLIPSEUR - PVC (coin intérieur 90° - 90 mm - CLIPS SLL)	2814	105	DAGKANT ELEMENT WAB oranje (verzinkt) - 156-180 mm	1173	25
COUVRE JOINT À CLIPSEUR - PVC (plat - 50 mm - CLIPS S)	2801	105	DAGKANT ELEMENT WAB oranje (verzinkt) - 181-215 mm	1174	25
COUVRE JOINT À CLIPSEUR - PVC (plat - 70 mm - CLIPS S)	2803	105	DAGKANT ELEMENT WAB oranje (verzinkt) - 216-270 mm	1175	25
COUVRE JOINT À CLIPSEUR - PVC (plat - 70 mm - CLIPS SLL)	2803	105	DAGKANT ELEMENT WAB oranje (verzinkt) - 271-365 mm	1176	25
COUVRE JOINT À CLIPSEUR - PVC (plat - 90 mm - CLIPS S)	2804	105	DAGKANT ELEMENT WAB oranje (verzinkt) - 366-450 mm	1177	25
COUVRE JOINT À CLIPSEUR - PVC (plat - 90 mm - CLIPS SLL)	2804	105	DAGKANT ELEMENT WR groen (aluminium) - 110-135 mm	1261	24
C-PLAFONDPROFIELEN C 60/27	3019	38	DAGKANT ELEMENT WR groen (aluminium) - 136-155 mm	1262	24
C-VERTICALE PROFIELEN C 50/50	3010	36	DAGKANT ELEMENT WR groen (aluminium) - 156-180 mm	1263	24
C-VERTICALE PROFIELEN C 70/50	3097	36	DAGKANT ELEMENT WR groen (aluminium) - 181-215 mm	1264	24
C-VERTICALE PROFIELEN C 75/50	3015	36	DAGKANT ELEMENT WR groen (aluminium) - 216-270 mm	1265	24
C-VERTICALE PROFIELEN C 100/50	3016	36	DAGKANT ELEMENT WR groen (aluminium) - 271-365 mm	1266	24
C-VERTICALE PROFIELEN C 125/50	3098	37	DAGKANT ELEMENT WR groen (aluminium) - 366-450 mm	1267	24
C-VERTICALE PROFIELEN C 150/50	3099	37	DAGKANT ELEMENT WR groen (verzinkt) - 110-135 mm	1161	23
DAGKANT ELEMENT (aluminium) - 110-145 mm	1251	22	DAGKANT ELEMENT WR groen (verzinkt) - 136-155 mm	1162	23
DAGKANT ELEMENT (aluminium) - 146-170 mm	1252	22	DAGKANT ELEMENT WR groen (verzinkt) - 156-180 mm	1163	23
DAGKANT ELEMENT (aluminium) - 171-195 mm	1253	22	DAGKANT ELEMENT WR groen (verzinkt) - 181-215 mm	1164	23
DAGKANT ELEMENT (aluminium) - 196-234 mm	1254	22	DAGKANT ELEMENT WR groen (verzinkt) - 216-270 mm	1165	23
DAGKANT ELEMENT (aluminium) - 235 mm	1255	22	DAGKANT ELEMENT WR groen (verzinkt) - 271-365 mm	1166	23
DAGKANT ELEMENT (aluminium) - 236-295 mm	1256	22	DAGKANT ELEMENT WR groen (verzinkt) - 366-450 mm	1167	23
DAGKANT ELEMENT (aluminium) - 296-395 mm	1257	22			
DAGKANT ELEMENT (aluminium) - 396-450 mm	1258	22			
DAGKANT ELEMENT (verzinkt) - 110-145 mm	1151	21			
DAGKANT ELEMENT (verzinkt) - 146-170 mm	1152	21			
DAGKANT ELEMENT (verzinkt) - 171-195 mm	1153	21			
DAGKANT ELEMENT (verzinkt) - 196-234 mm	1154	21			
DAGKANT ELEMENT (verzinkt) - 235 mm	1155	21			
DAGKANT ELEMENT (verzinkt) - 236-295 mm	1156	21			
DAGKANT ELEMENT (verzinkt) - 296-395 mm	1157	21			
DAGKANT ELEMENT (verzinkt) - 396-450 mm	1158	21			

## GLOSSAIRE PAR ORDRE ALPHABÉTIQUE ALFABETISCHE RANGSCHIKKING

NOM NAAM	N°	PAGE PAGINA	NOM NAAM	N°	PAGE PAGINA
DILAT PVC (3 mm)	8503	70	FASSATEX (bleu/blauw - 145 gr/m <sup>2</sup> - 50 m X 50 cm)	4146	110
DILAT PVC (6 mm)	8506	70	FASSATEX (bleu/blauw - 145 gr/m <sup>2</sup> - 50 m X 100 cm)	4141	110
DILAT PVC (10 mm)	8510	71, 101	FASSATEX (orange/oranje - 145 gr/m <sup>2</sup> - 50 m X 100 cm)	4142	110
DILAT PVC (10 mm - beige)	9511	101	FIBATAPE APPLICATOR	4846	30
DILAT PVC (10 mm - gris/grijs)	9510	101	FIBATAPE (20 m X 48 mm)	4820	27
DILAT PVC (15 mm)	8515	102	FIBATAPE (45 m X 48 mm)	4845	27
DILAT PVC (15 mm - beige)	9516	102	FIBATAPE (90 m X 48 mm)	4890	27
DILAT PVC (15 mm - gris/grijs)	9515	102	FIBATAPE (90 m X 100 mm)	4190	27
DILAT PVC GWS "E" (3 mm)	8035	124	FIBATAPE MOLD X10 (90 m X 48 mm)	4892	27
DILAT PVC GWS "V" (3 mm)	8034	124	FIBATAPE PERFECT FINISH (90 m X 48 mm)	4894	28
DILAT PVC GWS (6 mm)	8030	124	FIL À GILLET (125 mm)	3041	43
DILAT PVC GWS (6 mm - beige)	9004	124	FIL À GILLET (250 mm)	3041	43
DILAT PVC GWS (6 mm - gris/grijs)	9005	124	FIL À GILLET (375 mm)	3041	43
DILAT PVC INOX MAXI (6 + 12 mm)	2407	125	FIL À GILLET (500 mm)	3041	43
DILAT PVC INOX MINI (6 + 8 mm)	2406	125	FIL À GILLET (750 mm)	3041	43
DILATGAL (10 mm)	2001	71, 101	FIL À GILLET (1000 mm)	3041	43
DILATGAL (15 mm)	2002	102	FIL À GILLET (1250 mm)	3041	43
DILATGAL (20 mm)	2003	103	FIL À GILLET (1500 mm)	3041	43
DILATGAL COLOR (10 mm - beige)	9001	101	FIL À GILLET (1750 mm)	3041	43
DILATGAL COLOR (15 mm - beige)	9002	102	FIL À GILLET (2000 mm)	3041	43
DILATGAL COLOR (20 mm - beige)	9003	103	FLEX JOINT PVC (1 mm)	8511	20
DILATINOX (8 mm)	2404	70	GALSTOP (3 mm)	0120	60
DILATINOX (10 mm)	2401	71, 101	GALSTOP (6 mm)	0126	61
DILATINOX (15 mm)	2402	102	GALSTOP (6 mm)	0127	61
DILATINOX COLOR (10 mm - beige)	9401	101	GALSTOP (9 mm)	0122	62
DILATINOX COLOR (15 mm - beige)	9402	102	GALSTOP COLOR (6 mm)	0627	61
DILATMESH (1 mm)	2191	19	GALSTOP PVC (10 mm)	2004	92
DILATPLAC PVC (1 mm)	8501	19	GALSTOP PVC (15 mm)	2005	94
DIRECT HANGER (60 mm)	3044	40	GALSTOP PVC (20 mm)	2170	96
DIRECT HANGER (125 mm)	3045	40	GALSTOP PVC COLOR (10 mm - beige)	9160	92
DIRECT HANGER (200 mm)	3046	40	GALSTOP PVC COLOR (10 mm - gris/grijs)	9160	92
DRAAD ZONDER OOG	3040	43	GALSTOP PVC COLOR (15 mm - beige)	9165	94
DRAAIENDE SNELSPANCLIP (voor plafond < 25 kg/m <sup>2</sup> )	3035	41	GALSTOP PVC COLOR (15 mm - gris/grijs)	9165	94
DUBBEL VEER	3036	42	GALTO (25 mm)	6018	108
DUBBEL VEER MET DRADEN (30/60 mm)	3037	42	GALTO (25 mm)	6028	109
DUBBEL VEER MET DRADEN (60/100 mm)	3037	42	GALTO INOX (25 mm)	6418	108
EXPRESS PLAFONDPLUG	3052	46	GALTO INOX (25 mm)	6428	109
FASSATEX (blanc/wit - 145 gr/m <sup>2</sup> - 50 m X 33 cm)	4143	110	GALTO PVC (25 mm)	6828	109
FASSATEX (blanc/wit - 145 gr/m <sup>2</sup> - 50 m X 50 cm)	4144	110	GALTO SCHAAR	1207	113
FASSATEX (blanc/wit - 145 gr/m <sup>2</sup> - 50 m X 100 cm)	4140	110	GALVAPLAC (1 mm)	0114	7
FASSATEX (blanc/wit - 200 gr/m <sup>2</sup> - 50 m X 100 cm)	4210	111	GALVAPLAC ECO (1 mm)	0164	7
FASSATEX (blanc/wit - 220 gr/m <sup>2</sup> - 50 m X 100 cm)	4220	111	GRIP-LATT PLUS (20 mm)	6000	75, 108
FASSATEX (blanc/wit - 330 gr/m <sup>2</sup> - 25 m X 100 cm)	4330	111	GWS EXTRA (3 mm)	8113	116
FASSATEX (bleu/blauw - 145 gr/m <sup>2</sup> - 50 m X 33 cm)	4145	110	GWS ISOCORNER (3 mm)	8313	118
			INOPLAC (1 mm)	0494	7
			INOPLAC GWS (3 mm)	0495	116
			INOSOCLE (30 mm)	0471	130
			INOSOCLE (40 mm)	0472	130



## GLOSSAIRE PAR ORDRE ALPHABÉTIQUE ALFABETISCHE RANGSCHIKKING

NOM NAAM	N°	PAGE PAGINA	NOM NAAM	N°	PAGE PAGINA
INOSOCLE (50 mm)	0473	130	ISOCOVER ALU (150 - 120 mm)	0320	132
INOSOCLE (60 mm)	0474	130	ISOCOVER ALU (160 - 130 mm)	0321	132
INOSOCLE (70 mm)	0475	130	ISOCOVER ALU (170 - 140 mm)	0322	132
INOSOCLE (80 mm)	0476	130	ISOCOVER ALU (180 - 150 mm)	0323	132
INOSOCLE (100 mm)	0478	130	ISOCOVER ALU (190 - 160 mm)	0324	132
INOSOCLE (120 mm)	0480	130	ISOCOVER ALU (200 - 170 mm)	0325	132
INOSOCLE (140 mm)	0482	130	ISOCOVER JOINT	1620	142
INOSOCLE (160 mm)	0484	130	ISOFIX DSH K (clou PVC/PVCnagel - 10 X 90 mm)	1602	138
INOSOCLE (180 mm)	0486	130	ISOFIX DSH K (clou PVC/PVCnagel - 10 X 110 mm)	1603	138
INOSTOP (3 mm)	0425	60	ISOFIX DSH K (clou PVC/PVCnagel - 10 X 130 mm)	1604	138
INOSTOP (6 mm)	0426	61	ISOFIX DSH K (clou PVC/PVCnagel - 10 X 140 mm)	1605	138
INOSTOP (6 mm)	0427	61	ISOFIX DSH K (clou PVC/PVCnagel - 10 X 150 mm)	1606	138
INOSTOP (9 mm)	0422	62, 91	ISOFIX DSH K (clou PVC/PVCnagel - 10 X 160 mm)	1607	138
INOSTOP (12 mm)	0462	94	ISOFIX DSH K (clou PVC/PVCnagel - 10 X 170 mm)	1608	138
ISO CONNECT	1612	142	ISOFIX DSH K (clou PVC/PVCnagel - 10 X 190 mm)	1610	138
ISOBORD ALU (30 mm)	0360	133	ISOFIX DSH K (clou PVC/PVCnagel - 10 X 100 mm)	1601	138
ISOBORD ALU (40 mm)	0361	133	ISOFIX GECKO (8 X 100 mm)	1601	138
ISOBORD ALU (50 mm)	0362	133	ISOFIX MAXI TSD (clou métal/metaalnagel - 8 X 80 mm)	1621	140
ISOBORD ALU (60 mm)	0363	133	ISOFIX MAXI TSD (clou métal/metaalnagel - 8 X 100 mm)	1622	140
ISOBORD ALU (70 mm)	0364	133	ISOFIX MAXI TSD (clou métal/metaalnagel - 8 X 120 mm)	1623	140
ISOBORD ALU (80 mm)	0365	133	ISOFIX MAXI TSD (clou métal/metaalnagel - 8 X 140 mm)	1624	140
ISOBORD ALU (90 mm)	0298	133	ISOFIX MAXI TSD (clou métal/metaalnagel - 8 X 160 mm)	1625	140
ISOBORD ALU (100 mm)	0366	133	ISOFIX MAXI TSD (clou métal/metaalnagel - 8 X 180 mm)	1626	140
ISOBORD ALU (110 mm)	0299	133	ISOFIX MAXI TSD (clou métal/metaalnagel - 8 X 200 mm)	1627	140
ISOBORD ALU (120 mm)	0367	133	ISOFIX MAXI TSD (clou métal/metaalnagel - 8 X 220 mm)	1628	140
ISOBORD ALU (130 mm)	0300	133	ISOFIX MAXI TSD (clou métal/metaalnagel - 8 X 240 mm)	1629	140
ISOBORD ALU (140 mm)	0368	133	ISOFIX MAXI TSD (clou métal/metaalnagel - 8 X 260 mm)	1630	140
ISOBORD ALU (150 mm)	0301	133	ISOFIX MAXI TSD (clou métal/metaalnagel - 8 X 280 mm)	1631	140
ISOBORD ALU (160 mm)	0302	133	ISOFIX MAXI TSD (clou métal/metaalnagel - 8 X 300 mm)	1632	140
ISOBORD ALU (170 mm)	0303	133	ISOFIX MAXI TSD-V KN (clou PVC/PVCnagel - 8 X 100 mm)	1633	139
ISOBORD ALU (180 mm)	0304	133	ISOFIX MAXI TSD-V KN (clou PVC/PVCnagel - 8 X 120 mm)	1634	139
ISOBORD ALU (190 mm)	0305	133	ISOFIX MAXI TSD-V KN (clou PVC/PVCnagel - 8 X 140 mm)	1635	139
ISOBORD ALU (200 mm)	0306	133	ISOFIX MAXI TSD-V KN (clou PVC/PVCnagel - 8 X 160 mm)	1636	139
ISOBORD ALU (210 mm)	0307	133			
ISOBORD ALU (220 mm)	0308	133			
ISOBORD ALU (230 mm)	0309	133			
ISOBORD ALU (240 mm)	0310	133			
ISOBORD ALU (250 mm)	0311	133			
ISOCALÉ (3 mm)	1671	143			
ISOCALÉ (5 mm)	1672	143			
ISOCALÉ (8 mm)	1673	143			
ISOCALÉ (10 mm)	1674	143			
ISOCALÉ (15 mm)	1675	143			
ISOCOVER ALU (70 - 40 mm)	0389	132			
ISOCOVER ALU (80 - 50 mm)	0390	132			
ISOCOVER ALU (90 - 60 mm)	0317	132			
ISOCOVER ALU (100 - 70 mm)	0391	132			
ISOCOVER ALU (110 - 80 mm)	0318	132			
ISOCOVER ALU (120 - 90 mm)	0392	132			
ISOCOVER ALU (130 - 100 mm)	0319	132			
ISOCOVER ALU (140 - 110 mm)	0393	132			

## GLOSSAIRE PAR ORDRE ALPHABÉTIQUE ALFABETISCHE RANGSCHIKKING

NOM NAAM	N°	PAGE PAGINA	NOM NAAM	N°	PAGE PAGINA
ISOFIX MAXI TSD-V KN (clou PVC/PVCnagel - 8 X 180 mm)	1637	139	JOUE DE FENÊTRE WAB orange (galva) - 156-180 mm	1173	25
ISOFIX MAXI TSD-V KN (clou PVC/PVCnagel - 8 X 200 mm)	1638	139	JOUE DE FENÊTRE WAB orange (galva) - 181-215 mm	1174	25
ISOFIX MAXI TSD-V KN (clou PVC/PVCnagel - 8 X 220 mm)	1639	139	JOUE DE FENÊTRE WAB orange (galva) - 216-270 mm	1175	25
ISOFIX MAXI TSD-V KN (clou PVC/PVCnagel - 8 X 240 mm)	1640	139	JOUE DE FENÊTRE WAB orange (galva) - 271-365 mm	1176	25
ISOFIX MAXI TSD-V KN (clou PVC/PVCnagel - 8 X 260 mm)	1641	139	JOUE DE FENÊTRE WAB orange (galva) - 366-450 mm	1177	25
ISOFIX MAXI TSD-V KN (clou PVC/PVCnagel - 8 X 280 mm)	1642	139	JOUE DE FENÊTRE WR verte (aluminium) - 110-135 mm	1261	24
ISOFIX MAXI TSD-V KN (clou PVC/PVCnagel - 8 X 300 mm)	1643	139	JOUE DE FENÊTRE WR verte (aluminium) - 136-155 mm	1262	24
ISOKIT	1600	142	JOUE DE FENÊTRE WR verte (aluminium) - 156-180 mm	1263	24
ISOTEX (blanc/wit - 160 gr/m <sup>2</sup> - 50 m X 100 cm)	4165	141	JOUE DE FENÊTRE WR verte (aluminium) - 181-215 mm	1264	24
ISOTEX (blanc/wit - 160 gr/m <sup>2</sup> - 50 m X 110 cm)	4167	141	JOUE DE FENÊTRE WR verte (aluminium) - 216-270 mm	1265	24
ISOTEX (orange/oranje - 160 gr/m <sup>2</sup> - 50 m X 100 cm)	4166	141	JOUE DE FENÊTRE WR verte (aluminium) - 271-365 mm	1266	24
JOINT TAPE BESTAPE	4090	27	JOUE DE FENÊTRE WR verte (aluminium) - 366-450 mm	1267	24
JOUE DE FENÊTRE (aluminium) - 110-145 mm	1251	22	JOUE DE FENÊTRE WR verte (galva) - 110-135 mm	1161	23
JOUE DE FENÊTRE (aluminium) - 146-170 mm	1252	22	JOUE DE FENÊTRE WR verte (galva) - 136-155 mm	1162	23
JOUE DE FENÊTRE (aluminium) - 171-195 mm	1253	22	JOUE DE FENÊTRE WR verte (galva) - 156-180 mm	1163	23
JOUE DE FENÊTRE (aluminium) - 196-234 mm	1254	22	JOUE DE FENÊTRE WR verte (galva) - 181-215 mm	1164	23
JOUE DE FENÊTRE (aluminium) - 235 mm	1255	22	JOUE DE FENÊTRE WR verte (galva) - 216-270 mm	1165	23
JOUE DE FENÊTRE (aluminium) - 236-295 mm	1256	22	JOUE DE FENÊTRE WR verte (galva) - 271-365 mm	1166	23
JOUE DE FENÊTRE (aluminium) - 296-395 mm	1257	22	JOUE DE FENÊTRE WR verte (galva) - 366-450 mm	1167	23
JOUE DE FENÊTRE (aluminium) - 396-450 mm	1258	22	KRUISVERBINDER (geplooid)	3013	39
JOUE DE FENÊTRE (galva) - 110-145 mm	1151	21	KRUISVERBINDER (te plooiën)	3029	39
JOUE DE FENÊTRE (galva) - 146-170 mm	1152	21	MICROFIX	1033	29
JOUE DE FENÊTRE (galva) - 171-195 mm	1153	21	MICROMESH (1 mm)	0113	6
JOUE DE FENÊTRE (galva) - 196-234 mm	1154	21	MINIGYP (3 mm)	0110	48
JOUE DE FENÊTRE (galva) - 235 mm	1155	21	MINIGYP (3 mm)	0111	48
JOUE DE FENÊTRE (galva) - 236-295 mm	1156	21	MINIGYP ALU (3 mm)	0211	48
JOUE DE FENÊTRE (galva) - 296-395 mm	1157	21	MINIGYP INOX (3 mm)	0411	48, 116
JOUE DE FENÊTRE (galva) - 396-450 mm	1158	21	MINIMESH (3 mm)	0131	48
JOUE DE FENÊTRE WAB orange (aluminium) - 110-135 mm	1271	26	MOUCHOIR (coin/hoek - 10 cm)	4171	141
JOUE DE FENÊTRE WAB orange (aluminium) - 136-155 mm	1272	26	MOUCHOIR (coin/hoek - 20 cm)	4172	141
JOUE DE FENÊTRE WAB orange (aluminium) - 156-180 mm	1273	26	MOUCHOIR (plat/vlak - 33 X 50 cm)	4170	141
JOUE DE FENÊTRE WAB orange (aluminium) - 181-215 mm	1274	26	MS CLIPS	3061	44
JOUE DE FENÊTRE WAB orange (aluminium) - 216-270 mm	1275	26	MULTI COUP SCHAAR	1205	32, 79, 112, 144
JOUE DE FENÊTRE WAB orange (aluminium) - 271-365 mm	1276	26	NER-LATT (20 mm)	6100	75, 108
JOUE DE FENÊTRE WAB orange (aluminium) - 366-450 mm	1277	26	NER-LATT INOX (20 mm)	6400	75, 108
JOUE DE FENÊTRE WAB orange (galva) - 110-135 mm	1171	25			
JOUE DE FENÊTRE WAB orange (galva) - 136-155 mm	1172	25			

## GLOSSAIRE PAR ORDRE ALPHABÉTIQUE ALFABETISCHE RANGSCHIKKING

NOM NAAM	N°	PAGE PAGINA	NOM NAAM	N°	PAGE PAGINA
NONIUS BOVENHANGER (140 mm)	3081	44	PINCE MULTI COUP	1205	32, 79, 112, 144
NONIUS BOVENHANGER (340 mm)	3083	44	PINCE POUR PROFILÉS	1200	31, 79, 112, 143
NONIUS BOVENHANGER (440 mm)	3084	44	PINCE POUR PROFILÉS (rouge-gaucher)	1202	31, 79, 112, 143
NONIUS BOVENHANGER (540 mm)	3085	44	PINCE POUR PROFILÉS (vert-droitier)	1201	31, 79, 112, 143
NONIUS BOVENHANGER (640 mm)	3086	44	PINCE PVC APU Z12	1210	80, 113, 144
NONIUS BOVENHANGER (740 mm)	3087	44	PLACSTOP ALU (1 mm - 12,5 mm)	0229	13
NONIUS BOVENHANGER (840 mm)	3088	44	PLACSTOP L (1 mm - 9,5 mm)	0133	12
NONIUS BOVENHANGER (940 mm)	3089	44	PLACSTOP L (1 mm - 12,5 mm)	0130	12
NONIUS BOVENHANGER (1140 mm)	3090	44	PLACSTOP L (1 mm - 15 mm)	0136	12
NONIUS BOVENHANGER (1340 mm)	3091	44	PLACSTOP L INOX (1 mm - 12,5 mm)	0431	12
NONIUS ÉPINGLE	3092	45	PLACSTOP LIPPE PVC (1 mm - 12,5 mm)	8825	15
NONIUS ONDERDEEL HANGER (voor plafond > 25 kg/m²)	3093	45	PLACSTOP PVC (1 mm - 12,5 mm)	8025	13
NONIUS SUSPENTE INFÉRIEURE (Pour plafond > à 25 kg/m²)	3093	45	PLACSTOP PVC (1 mm - 12,5 mm)	8125	13
NONIUS SUSPENTE SUPÉRIEURE (140 mm)	3081	44	PLACSTOP PVC (1 mm - 15 mm)	8215	13
NONIUS SUSPENTE SUPÉRIEURE (340 mm)	3083	44	PLACSTOP PVC (9,5 mm)	8126	14
NONIUS SUSPENTE SUPÉRIEURE (440 mm)	3084	44	PLACSTOP PVC (12,5 mm)	8127	14
NONIUS SUSPENTE SUPÉRIEURE (540 mm)	3085	44	PLACSTOP PVC (15 mm)	8128	14
NONIUS SUSPENTE SUPÉRIEURE (640 mm)	3086	44	PLACSTOP RONDO PVC (1 mm - 12,5 mm)	8225	14
NONIUS SUSPENTE SUPÉRIEURE (740 mm)	3087	44	PLACSTOP TAPE PVC (1 mm - 12,5 mm)	8812	14
NONIUS SUSPENTE SUPÉRIEURE (840 mm)	3088	44	PLACSTOP TAPE PVC (1 mm - 15 mm)	8815	14
NONIUS SUSPENTE SUPÉRIEURE (940 mm)	3089	44	PLACSTOP Z (1 mm - 9,5 - 25 mm)	0195	17
NONIUS SUSPENTE SUPÉRIEURE (1140 mm)	3090	44	PLASTO MICRO (1 mm - 9,5 mm)	0191	12
NONIUS SUSPENTE SUPÉRIEURE (1340 mm)	3091	44	PLASTO MICRO (1 mm - 12,5 mm)	0128	12
PAPER CORNER BEAD (1 mm)	5301	9	PLASTO MICRO (1 mm - 15 mm)	0192	12
PAPER JOINT TAPE (76 m X 5,2 cm)	1022	29	PLASTO MICRO (1 mm - 18 mm)	0193	12
PAPER STOP BEAD (1 mm - 12,5 mm)	5305	15	PLASTO MICRO (1 mm - 25 mm)	0194	12
PER PVC FLEX GWS (3 mm)	8129	117	PLASTOP (9 mm)	0023	63
PER PVC GWS ECO (3 mm - blanc/wit)	8413	117	PLASTOP (9 mm)	0123	63
PER PVC GWS PRO (3 mm - blanc/wit)	8213	117	PLASTOP (12 mm)	0124	64
PER PVC GWS PRO (3 mm - bleu/blauw)	8211	117	POUTRECLIPS	1013	78
PER PVC GWS PRO (3 mm - jaune/geel)	8212	117	PROFI INTER ECO LIPPE (6 mm)	8866	72
PER PVC GWS PRO (3 mm - orange/oranje)	8214	117	PROFI INTER GWS LIPPE (6 mm)	8808	136
PER PVC GWS PRO 10 X 23 mm (3 mm - blanc/wit)	8219	118	PROFI INTER GWS LIPPE COLOR (6 mm)	9808	136
PER PVC GWS PRO 10 X 30 mm (3 mm - blanc/wit)	8220	118	PROFI INTER GWS PRO (6 mm)	8167	136
PER PVC MAXI GWS (6 mm)	8114	120	PROFI INTER PRO (6 mm)	8166	72
PER PVC RONDO GWS (3 mm)	8123	117	PROFI MINI GWS LIPPE (9 mm)	8809	137
PERALU (7 mm)	0212	51	PROFI MINI GWS LIPPE COLOR (9 mm)	9809	137
PERCAR (7 mm)	0138	53	PROFI MINI GWS PRO (9 mm)	8168	137
PERCAR (7 mm)	0139	54	PROFI MINI LIPPE (9 mm)	8888	73
PERCAR ALU (7 mm)	0238	53	PROFI MINI PRO (9 mm)	8108	73
PERCAR INOX (7 mm)	0438	53	PROFIEL SCHAAR	1200	31, 79, 112, 143
PERFOR (7 mm)	0112	51	PROFIEL SCHAAR (groen-rechtshandig)	1201	31, 79, 112, 143
PERFOR PVC (10 mm)	2112	85	PROFIEL SCHAAR (rood-linkshandig)	1202	31, 79, 112, 143
PERGYPLUS (7 mm)	0132	52	PROFILS C POUR PLAFONDS C 60/27	3019	38
PINCE À SERTIR LATT-FIX	1206	80, 113	PROFILS C VERTICAUX C 50/50	3010	36
PINCE À SERTIR METAL STUDS	1209	39			
PINCE GALTO	1207	113			

## GLOSSAIRE PAR ORDRE ALPHABÉTIQUE ALFABETISCHE RANGSCHIKKING

NOM NAAM	N°	PAGE PAGINA	NOM NAAM	N°	PAGE PAGINA
PROFILS C VERTICAUX C 70/50	3097	36	SLAGPLUGGEN 6-60 mm (kleine emmer)	3053	33
PROFILS C VERTICAUX C 75/50	3015	36	SLAGPLUGGEN 8-60 mm (klein zakje)	3055	33
PROFILS C VERTICAUX C 100/50	3016	36	SLAGPLUGGEN 8-80 mm (klein zakje)	3056	33
PROFILS C VERTICAUX C 125/50	3098	37	SOCLE PVC GWS PRO (80 mm)	8441	131
PROFILS C VERTICAUX C 150/50	3099	37	SOCLE PVC GWS PRO (100 mm)	8443	131
PROFILS U HORIZONTAUX U 50/40	3000	34	SOCLE PVC GWS PRO (120 mm)	8495	131
PROFILS U HORIZONTAUX U 70/40	3070	34	SOCLE PVC GWS PRO (140 mm)	8496	131
PROFILS U HORIZONTAUX U 75/40	3001	34	SOCLE PVC GWS PRO (150 mm)	8453	131
PROFILS U HORIZONTAUX U 100/40	3002	34	SOCLE PVC GWS PRO (160 mm)	8497	131
PROFILS U HORIZONTAUX U 125/40	3003	34	SOCLE PVC GWS PRO (180 mm)	8498	131
PROFILS U HORIZONTAUX U 150/40	3004	34	SOCLE PVC GWS PRO (200 mm)	8499	131
PROFILS U HORIZONTAUX U 50/40 + FOAM	3005	35	STOP ALU (12 mm)	0224	64, 93
PROFILS U HORIZONTAUX U 70/40 + FOAM	3014	35	STOP BEAD PVC (3 mm)	8633	60
PROFILS U HORIZONTAUX U 75/40 + FOAM	3006	35	STOP BEAD PVC (6 mm)	8666	62
PROFILS U HORIZONTAUX U 100/40 + FOAM	3007	35	STOP BEAD PVC (10 mm)	8610	64, 93
PROFILS U HORIZONTAUX U 125/40 + FOAM	3008	35	STOP BEAD PVC (10 mm - beige)	9611	93
PROFILS U HORIZONTAUX U 150/40 + FOAM	3009	35	STOP BEAD PVC (10 mm - gris/grijs)	9610	93
PROFILS U POUR PLAFONDS U 27/28	3020	38	STOP BEAD PVC (10 mm - gris/grijs)	9610	93
PROFILS U POUR PLAFONDS U 27/48	3022	38	STOP BEAD PVC (15 mm)	8615	95
PVC SCHAAR APU Z12	1210	80, 113, 144	STOP BEAD PVC (15 mm - beige)	9616	95
QUICK STICK (76 m)	1046	29	STOP BEAD PVC (15 mm - gris/grijs)	9615	95
RACCORD EN CROIX (à plier)	3029	39	STOP BEAD PVC (20 mm)	8620	96
RACCORD EN CROIX (plié)	3013	39	STOP ISO GWS (3 mm)	8233	126
RACCORD EN LONGUEUR	3030	40	STOP ISO GWS (6 mm)	8234	126
REGLALU (6 mm)	0240	67	STOP ISO GWS (6 mm)	8236	127
REGLALU (10 mm)	0241	68, 100	STOP ISO GWS (10 mm)	8231	127
REGLE (6 mm)	0140	67	STOP ISO GWS (10 mm)	8231	127
REGLE (10 mm)	0141	68	STOP ISO GWS DUO PRO (3 / 6 mm)	8235	126
REGLE ECO (6 mm)	0144	67	STOP PVC (10 mm)	2012	93
REGLE PVC (6 mm)	8031	68	STOP PVC (15 mm)	2013	94
REGLE PVC (10 mm)	8032	69, 100	STOP PVC (20 mm)	2014	95
REGLINOX (6 mm)	0440	67	STOP PVC GWS PRO (3 mm)	8703	122
REGLINOX (10 mm)	0441	68, 100	STOP PVC GWS PRO (6 mm)	8704	122
REND BEAD PVC (10 mm)	8710	97	STOP PVC GWS PRO (10 mm)	8705	122
REND BEAD PVC (10 mm - beige)	9711	97	STOP PVC GWS PRO (15 mm)	8706	123
REND BEAD PVC (10 mm - gris/grijs)	9710	97	STOPINOX (9 mm)	0420	63, 92
REND BEAD PVC (15 mm)	8715	98	STOPINOX (10 mm)	0423	63, 92
REND BEAD PVC (15 mm - beige)	9716	98	STOPINOX (12 mm)	0421	64, 93
REND BEAD PVC (15 mm - gris/grijs)	9715	98	STOPINOX (16 mm)	0424	95
REND PERFO PVC (10 mm)	2006	97	STRAITFLEX ARCH-FLEX 333 (1 mm)	5303	10
REND PERFO PVC (15 mm)	2007	98	STRAITFLEX EXTENSION POLE	1040	31
REND PVC (10 mm)	2008	97	STRAITFLEX MID FLEX 300 (1 mm)	5300	9
REND PVC (15 mm)	2009	98	STRAITFLEX MUD-PRO2	1038	30
REND PVC (20 mm)	2010	99	STRAITFLEX ROLLER 300 MID FLEX	1039	30
RONDO GYP PVC (6 mm)	8207	50	STUCLOPER (50 m² - +/- 0,9 X 55,55 m)	1016	78
RONDO PLAC PVC (1 mm)	8201	8	STUCLOPER (50 m² - +/- 1,2 X 41,66 m)	1017	78
SLAGPLUGGEN 5-35 mm (emmer)	3049	32	STUCLOPER ECO (65 m² - +/- 1,20 X 54,17 m)	1012	78
SLAGPLUGGEN 6-40 mm (emmer)	3051	32	STUDS FOAM (25 mm X 10 m)	3074	46
SLAGPLUGGEN 6-40 mm (kleine emmer)	3050	33	SUPLEX (15 mm)	0118	59
SLAGPLUGGEN 6-60 mm (emmer)	3054	32	SUPLEX INOX (15 mm)	0418	59, 87
			SUPLEX PVC (15 mm)	2118	89
			SUSPENSION RAPIDE ROTATIVE (pour plafond < à 25 kg/m²)	3035	41



# GLOSSAIRE PAR ORDRE ALPHABÉTIQUE

## ALFABETISCHE RANGSCHIKKING

NOM NAAM	N°	PAGE PAGINA	NOM NAAM	N°	PAGE PAGINA
SUSPENTE DOUBLE FIL NON MONTÉE	3036	42	VOEGAFDEKKINGSPROFIEL TE CLIPSEN - ALU (binnenhoek 90° - 120 mm - CLIPS SLL)	2215	104
SUSPENTE DOUBLE MONTÉE + FILS (30/60 mm)	3037	42	VOEGAFDEKKINGSPROFIEL TE CLIPSEN - ALU (binnenhoek 90° - 120 mm - CLIPS XL)	2215	104
SUSPENTE DOUBLE MONTÉE + FILS (60/100 mm)	3037	42	VOEGAFDEKKINGSPROFIEL TE CLIPSEN - ALU (vlak - 50 mm - CLIPS S)	2201	104
SUSPENTE PLATE POUR STRUCTURE BOIS (90 mm)	3038	41	VOEGAFDEKKINGSPROFIEL TE CLIPSEN - ALU (vlak - 70 mm - CLIPS S)	2203	104
SUSPENTE PLATE POUR STRUCTURE BOIS (120 mm)	3034	41	VOEGAFDEKKINGSPROFIEL TE CLIPSEN - ALU (vlak - 70 mm - CLIPS SLL)	2203	104
SUSPENTE PLATE POUR STRUCTURE BOIS (270 mm)	3043	41	VOEGAFDEKKINGSPROFIEL TE CLIPSEN - ALU (vlak - 90 mm - CLIPS S)	2204	104
SUSPENTE SUR BOIS (60 mm)	3044	40	VOEGAFDEKKINGSPROFIEL TE CLIPSEN - ALU (vlak - 90 mm - CLIPS SLL)	2204	104
SUSPENTE SUR BOIS (125 mm)	3045	40	VOEGAFDEKKINGSPROFIEL TE CLIPSEN - ALU (vlak - 120 mm - CLIPS SLL)	2205	104
SUSPENTE SUR BOIS (200 mm)	3046	40	VOEGAFDEKKINGSPROFIEL TE CLIPSEN - ALU (vlak - 120 mm - CLIPS XL)	2205	104
TIGE LISSE SANS CÉLLET	3040	43	VOEGAFDEKKINGSPROFIEL TE CLIPSEN - PVC (binnenhoek 90° - 50 mm - CLIPS S)	2811	105
U-HORIZONTALE PROFIELEN U 50/40	3000	34	VOEGAFDEKKINGSPROFIEL TE CLIPSEN - PVC (binnenhoek 90° - 70 mm - CLIPS S)	2813	105
U-HORIZONTALE PROFIELEN U 70/40	3070	34	VOEGAFDEKKINGSPROFIEL TE CLIPSEN - PVC (binnenhoek 90° - 70 mm - CLIPS SLL)	2813	105
U-HORIZONTALE PROFIELEN U 75/40	3001	34	VOEGAFDEKKINGSPROFIEL TE CLIPSEN - PVC (binnenhoek 90° - 90 mm - CLIPS S)	2814	105
U-HORIZONTALE PROFIELEN U 100/40	3002	34	VOEGAFDEKKINGSPROFIEL TE CLIPSEN - PVC (binnenhoek 90° - 90 mm - CLIPS SLL)	2814	105
U-HORIZONTALE PROFIELEN U 125/40	3003	34	VOEGAFDEKKINGSPROFIEL TE CLIPSEN - PVC (vlak - 50 mm - CLIPS S)	2801	105
U-HORIZONTALE PROFIELEN U 150/40	3004	34	VOEGAFDEKKINGSPROFIEL TE CLIPSEN - PVC (vlak - 70 mm - CLIPS S)	2803	105
U-HORIZONTALE PROFIELEN U 50/40 + FOAM	3005	35	VOEGAFDEKKINGSPROFIEL TE CLIPSEN - PVC (vlak - 70 mm - CLIPS SLL)	2803	105
U-HORIZONTALE PROFIELEN U 70/40 + FOAM	3014	35	VOEGAFDEKKINGSPROFIEL TE CLIPSEN - PVC (vlak - 90 mm - CLIPS S)	2804	105
U-HORIZONTALE PROFIELEN U 75/40 + FOAM	3006	35	VOEGAFDEKKINGSPROFIEL TE CLIPSEN - PVC (vlak - 90 mm - CLIPS SLL)	2804	105
U-HORIZONTALE PROFIELEN U 100/40 + FOAM	3007	35	VOEGEN CLIPS	3061	44
U-HORIZONTALE PROFIELEN U 125/40 + FOAM	3008	35	WET'FLEX (1 mm)	5307	11
U-HORIZONTALE PROFIELEN U 150/40 + FOAM	3009	35	WIDRA AP (15 mm)	0174	88
UNIFLEX CORNER (1 mm)	5230	9	WIDRA APA (15 mm)	0175	88
UNIFLEX CORNER PVC (1 mm)	5237	9	WIDRA APB (15 mm)	0176	88
U-PLAFONDPROFIELEN U 27/28	3020	38	WIDRA APBK (17 mm)	0177	90
U-PLAFONDPROFIELEN U 27/48	3022	38	WIDRA APE (15 mm)	0428	88
VEERKLEM VOOR NONIUS	3092	45	WIDRA APHK (17 mm)	0179	99
VERBINDINGSSTUK VOOR PLAFONDPROFIELEN	3030	40	WIDRA APK (17 mm)	0180	90
VERBINDINGSTANG LATT-FIX	1206	80, 113	WIDRA APP COLOR (15 mm - blanc/wit)	9174	88
VERBINDINGSTANG METAL STUDS	1209	39	WIDRA APS (15 mm)	0181	88
VLAkke OPHANGER VOOR HOUTEN STRUCTUUR (90 mm)	3038	41	WIDRA IP (10 mm)	0182	57, 82
VLAkke OPHANGER VOOR HOUTEN STRUCTUUR (120 mm)	3034	41	WIDRA IPE (10 mm)	0429	57, 82
VLAkke OPHANGER VOOR HOUTEN STRUCTUUR (270 mm)	3043	41			
VOEGAFDEKKINGSPROFIEL TE CLIPSEN - ALU (binnenhoek 90° - 50 mm - CLIPS S)	2211	104			
VOEGAFDEKKINGSPROFIEL TE CLIPSEN - ALU (binnenhoek 90° - 70 mm - CLIPS S)	2213	104			
VOEGAFDEKKINGSPROFIEL TE CLIPSEN - ALU (binnenhoek 90° - 70 mm - CLIPS SLL)	2213	104			
VOEGAFDEKKINGSPROFIEL TE CLIPSEN - ALU (binnenhoek 90° - 90 mm - CLIPS S)	2214	104			
VOEGAFDEKKINGSPROFIEL TE CLIPSEN - ALU (binnenhoek 90° - 90 mm - CLIPS SLL)	2214	104			